

Programat[®] P310 G2



Operating Instructions

Valid from
software V7.0

CE

ivoclar
vivadent[®]

Declaration of conformity



Declaration of conformity

Manufacturer Address Ivoclar Vivadent AG
Bendererstrasse 2
LI - 9494 Schaan
Liechtenstein

Product **Programat P310 / G2**

Type of material **Dental Laboratory Equipment**

Classification **Technical Device**

We herewith declare under our exclusive responsibility that the above mentioned products meet the provisions of the following EC Council Directives and its implementation in national law. All supporting documentation is retained on the premises of the manufacturer and, where applicable, the notified body.

| | | |
|------------|------------|-------------------------------------|
| Directives | 2014/35/EU | Low voltage |
| | 2014/30/EU | Electromagnetic compatibility |
| | 2011/65/EU | Restriction of hazardous substances |

| | |
|-----------|------------------------------------|
| Standards | EN 61010-1:2010 |
| | EN 61010-2-010:2020 |
| | EN 61326-1:2013 (Group 1, Class B) |
| | EN 61000-3-2:2014 |
| | EN 61000-3-3:2013 |
| | EN 63000:2018 |

Notified Body Address not applicable

Place, Valid from Schaan, 04.02.2021

Valid until 03.02.2026

Signature

Name

Position

Date

Markus Heinz

CPO Production & Logistics

04.02.2021

Dipl. Ing. Gottfried Rohner

Director Equipment Development

04.02.2021

Table of Contents

| | |
|---|-----------|
| List of parts | 4 |
| 1. Introduction / Signs and Symbols | 7 |
| 1.1 Introduction | 7 |
| 1.2 Signs and symbols contained in these Operating Instructions | 7 |
| 1.3 Notes regarding the Operating Instructions | 7 |
| 1.4 Notes on the different voltage versions | 8 |
| 1.5 Notes on the images in the Operating Instructions | 8 |
| 2. Safety First | 9 |
| 2.1 Indications | 9 |
| 2.2 Health and safety instructions | 12 |
| 3. Product Description | 14 |
| 3.1 General aspects | 14 |
| 3.2 Hazardous areas and safety equipment | 14 |
| 4. Installation and Initial Start-Up | 15 |
| 4.1 Unpacking and checking the contents | 15 |
| 4.2 Selecting the location | 15 |
| 4.3 Assembly | 16 |
| 4.4 Removing the furnace head | 19 |
| 4.5 Initial start-up | 19 |
| 5. Operation and Configuration | 23 |
| 5.1 Introduction to the operation | 23 |
| 5.2 Firing programs and programming options | 27 |
| 5.3 Managing programs | 39 |
| 5.4 Advanced functions of the furnace / Software Update | 41 |
| 5.5 IoT function | 53 |
| 6. Practical Use | 54 |
| 6.1 Firing with an Ivoclar Vivadent program | 54 |
| 6.2 Firing with an individual program | 55 |
| 7. Maintenance, Cleaning, Diagnosis | 57 |
| 7.1 Monitoring and maintenance | 57 |
| 7.2 Cleaning | 58 |
| 7.3 Service note | 58 |
| 7.4 Stand-by | 58 |
| 7.5 Power-saving mode | 58 |
| 8. What If ... | 59 |
| 8.1 Error messages | 59 |
| 8.2 Additional error messages | 61 |
| 8.3 Technical malfunctions | 62 |
| 8.4 Repair | 63 |
| 8.5 Resetting to factory settings | 63 |
| 9. Product Specifications | 65 |
| 9.1 Delivery form | 65 |
| 9.2 Technical data | 65 |
| 9.3 Acceptable operating conditions | 66 |
| 9.4 Acceptable transportation and storage conditions | 66 |
| 10. Appendix | 67 |
| 10.1 Program table | 67 |

List of parts

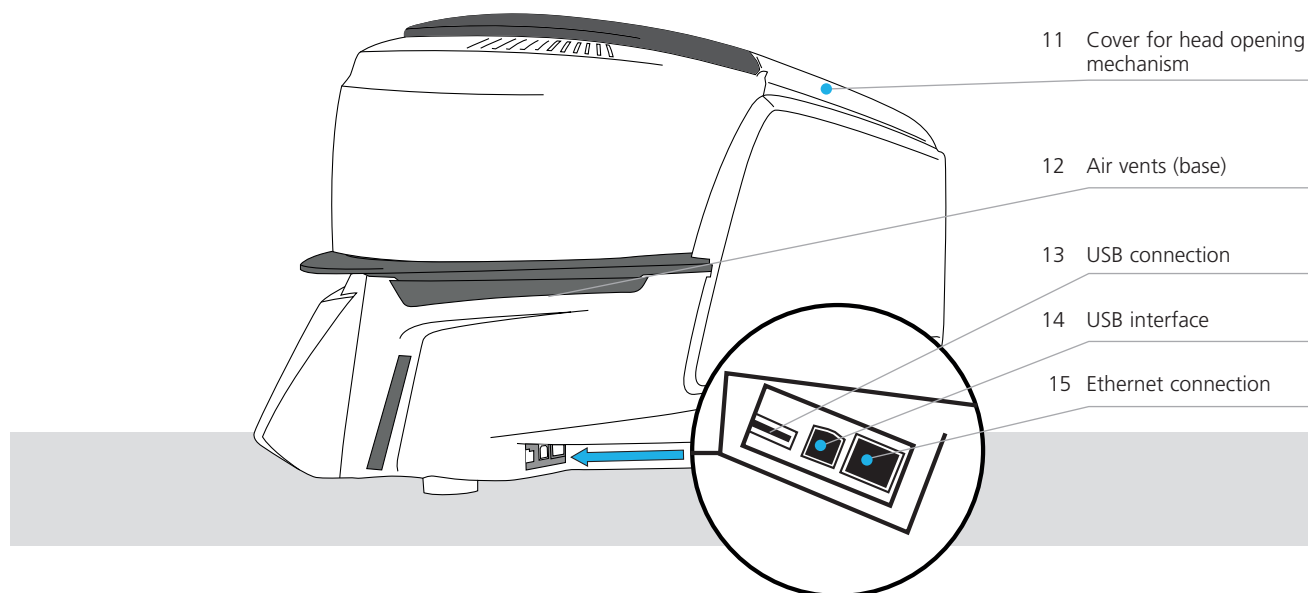
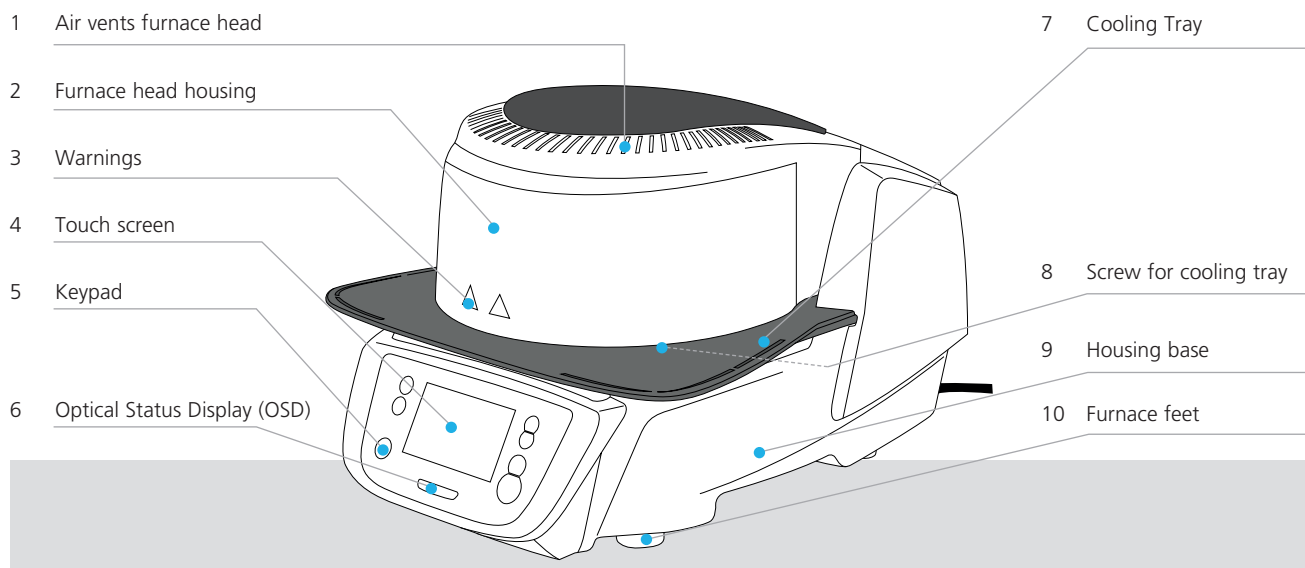

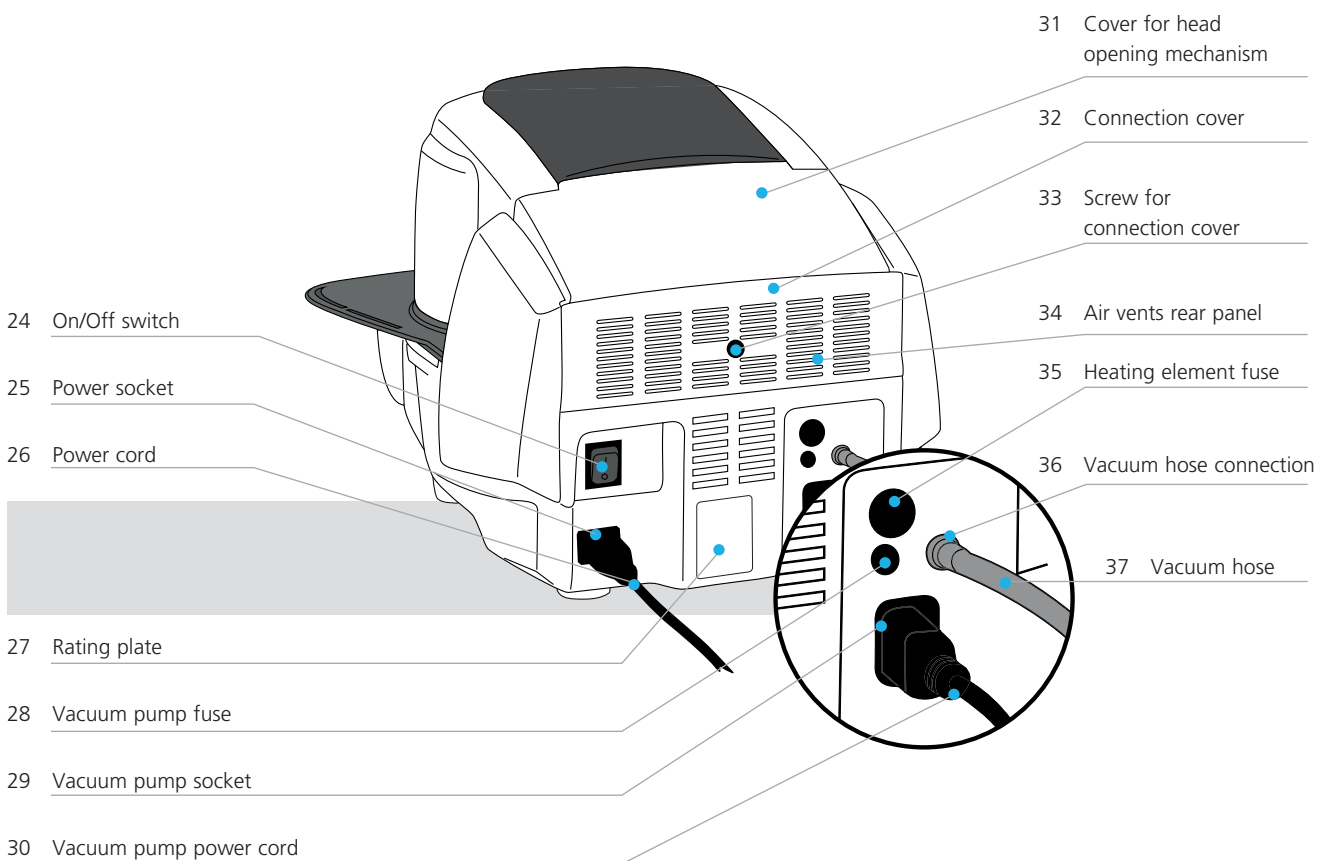
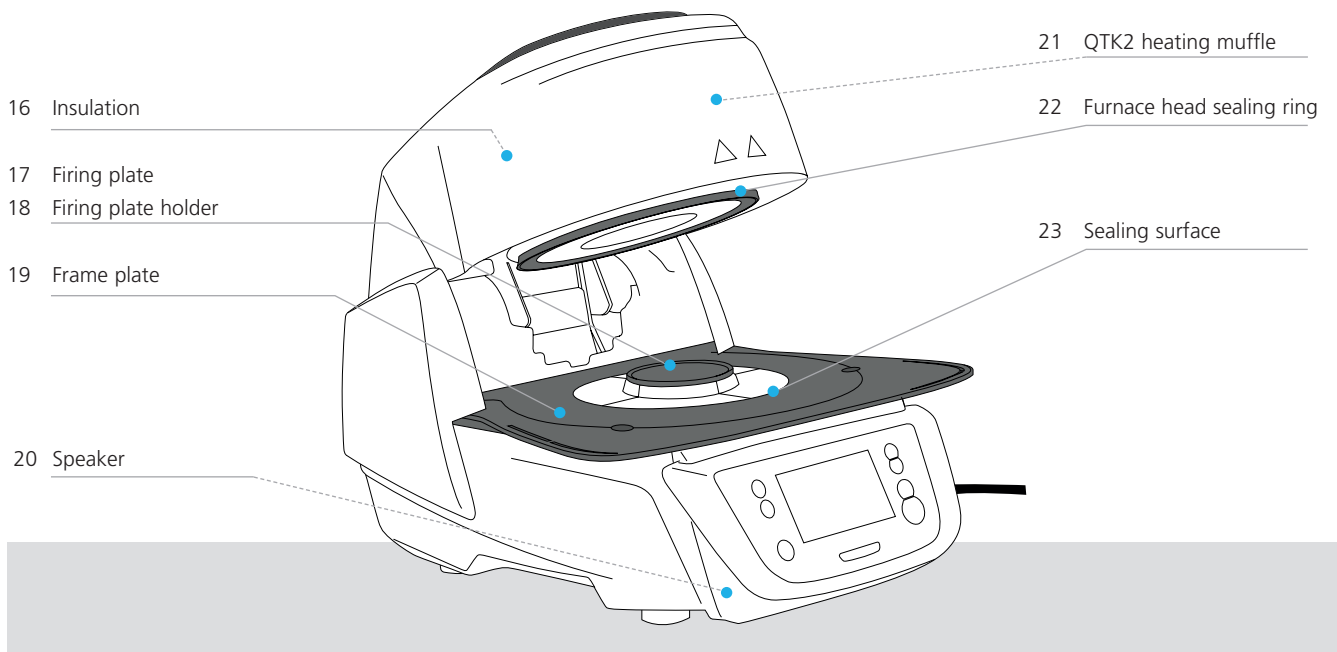

List of parts

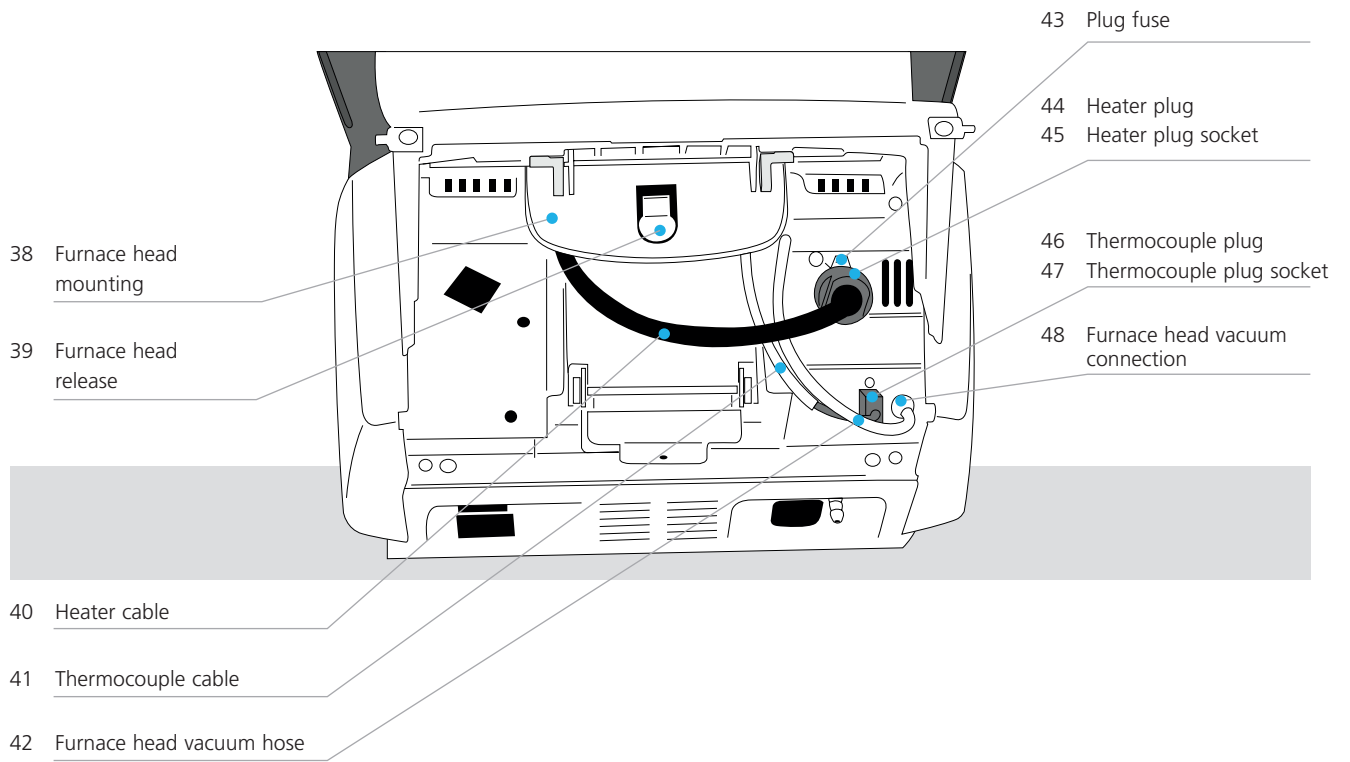

50 LAN download cable

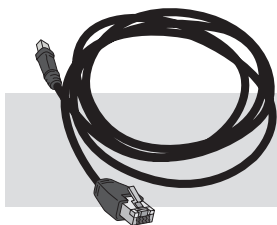

51 Programat Firing Tray Kit 2

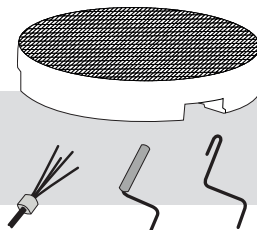

52 Programat USB stick

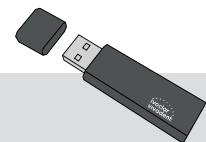

1. Introduction / Signs and Symbols

1.1 Introduction







Dear Customer

Thank you for having purchased the Programat P310 G2. It is a state-of-the-art furnace for dental applications. The furnace has been designed according to the latest industry standards. Inappropriate use may damage the equipment and be harmful to personnel. Please observe the relevant safety instructions and read the Operating Instructions carefully.

Enjoy working with the P310 G2.

1.2 Signs and symbols contained in these Operating Instructions

The signs and symbols in these Operating Instructions facilitate the finding of important points and have the following meanings:

| Symbol | Note |
|---|--|
|  | Risks and dangers |
|  | Important information |
|  | Contraindication |
|  | Burn hazard |
|  | Risk of crushing |
|  | The Operating Instructions must be read. |

1.3 Notes regarding the Operating Instructions



Furnace concerned: Programat P310 G2

Target group: Dental technologists, dental professionals

These Operating Instructions facilitate the correct, safe and economical use of the furnace. Should you lose the Operating Instructions, extra copies can be ordered at a nominal fee from your local Ivoclar Vivadent Service Centre or downloaded from www.ivoclarvivadent.com.

1. Introduction / Signs and Symbols

1.4 Notes on the different voltage versions

The furnace is available with different voltage versions.

– 110–120 V / 50–60 Hz

– 200–240 V / 50–60 Hz

In the Operating Instructions, the furnace is described in the 200–240 V voltage version. Please note that the voltage range shown on the images (e.g. rating plate) may differ depending on the voltage version of your furnace.

1.5 Notes on the images in the Operating Instructions

All images and illustrations in these Operating Instructions are used for exemplification and the details are not authoritative for the construction of the furnace. They are symbols which may slightly differ from the original, e.g. due to simplification.

2. Safety First



This chapter is especially important for individuals who work with the Programat P310 G2 or who have to carry out maintenance or repair work. This chapter must be read and the corresponding instructions followed!

2.1 Indications

The Programat P310 G2 must only be used to fire dental ceramic materials and it should be used for this purpose only. Other uses than the ones stipulated, e.g. cooking of food, firing of other materials, etc., are contraindicated. The manufacturer does not assume any liability for damage resulting from misuse. The user is solely responsible for any risk resulting from failure to observe these Instructions.

Further instructions to assure proper use of the furnace:

- The instructions, regulations, and notes in these Operating Instructions must be observed.
- The instructions, regulations, and notes in the material's Instructions for Use must be observed.
- The furnace must be operated under the indicated environmental and operating conditions (see Chapter 9.3).
- The Programat P310 G2 must be properly maintained.



Risks and dangers



The furnace head must not be removed from the furnace base as long as the furnace head is connected by means of the cables.

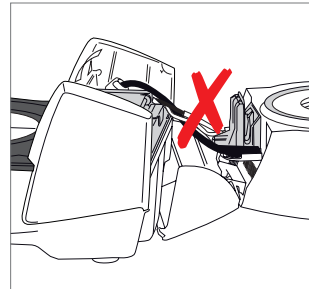

Make sure that no liquids or other foreign substances enter the furnace.



Burn hazard: Never place objects in the firing chamber by hand, since there is a burn hazard. Always use the tongs (accessories) supplied for this purpose.



Never touch the hot surface of the furnace head, as there is a burn hazard.

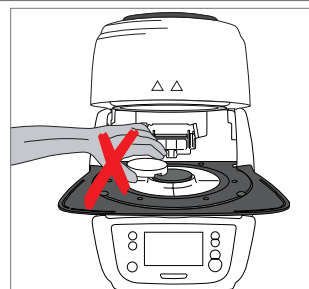

Do not carry the furnace by the cooling tray.

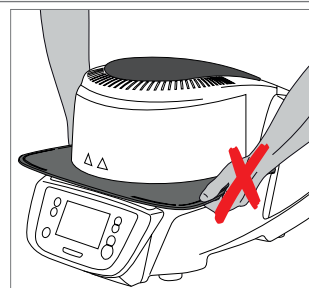

2. Safety First



Do not carry the furnace head by the cables, since the cables and connections may be damaged.

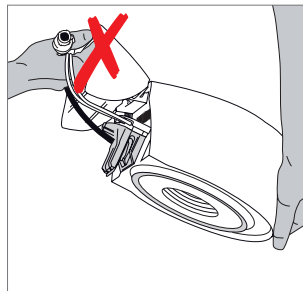

The furnace head has an electric drive and must be operated by means of the electronic controls. Never open the furnace head by hand, since the mechanism will be damaged.



The furnace must not be operated if the quartz tube in the firing chamber or the insulation of the firing chamber is damaged. There is a risk of electric shock upon contact with the heating wire. Avoid damage of the insulation by contact with the investment tongs or firing tongs.



Contraindication



Firing trays must not be placed in the area surrounding the firing plate, since this will obstruct the closing of the furnace head.

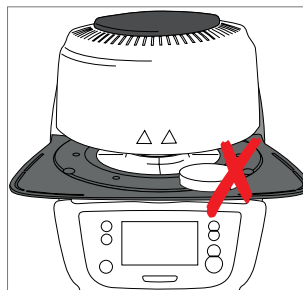

Foreign objects must not be placed on the furnace head or the air vents. Make sure that no liquids or other foreign objects enter the air vents, since this may result in an electrical shock.

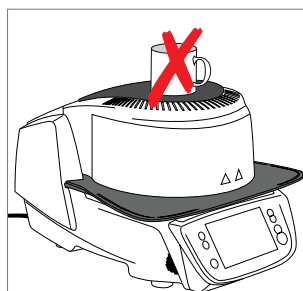

Never use the furnace without a firing table.





Do not touch the thermocouple and the quartz tube in the firing chamber. Avoid contact with the skin (grease contamination), as the parts may be prematurely damaged.

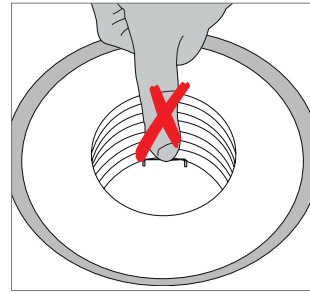

Do not insert any foreign objects into the air vents. There is a risk of electrical shock!

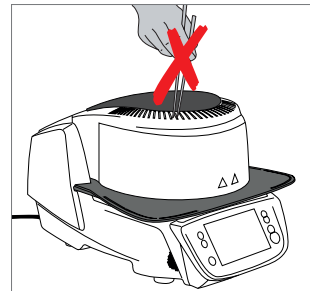

This product contains ceramic fibres and may release fibre dust. Do not use compressed air, or blow on the furnace thus distributing the dust in the environment and observe the additional notes on page 13.

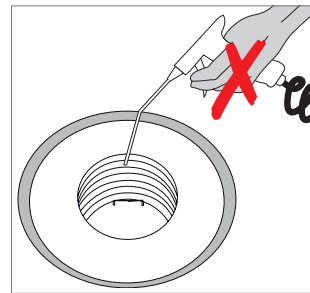

Risk of crushing / burn hazard



Never reach under the furnace head with the hand or other parts of the body, since there is a risk of crushing and a burn hazard.

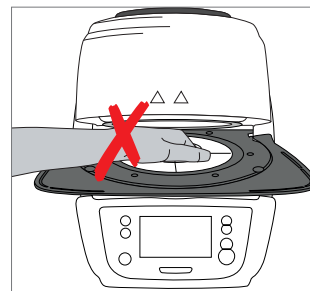

Never reach behind the rear cover with the hand or a finger in particular. There is a risk of crushing.

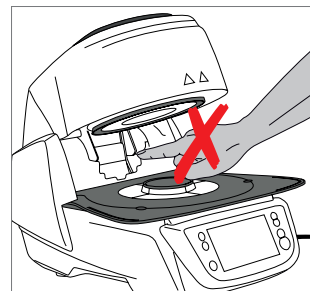

2. Safety First

2.2 Health and safety instructions

This furnace has been designed according to EN 61010-1 and has been shipped from the manufacturer in excellent condition as far as safety regulations are concerned. To maintain this condition and to ensure risk-free operation, the user must observe the notes and warnings contained in these Operating Instructions:

- The user must especially become familiar with the warnings and operating conditions to prevent injury to personnel or damage to materials. The manufacturer is not responsible for damage resulting from misuse or failure to observe the Operating Instructions. Warranty claims cannot be accepted in such cases.
- Before switching on the furnace, make sure that the voltage indicated on the rating plate complies with your local power supply.
- The power socket must be equipped with a residual current circuit breaker.
- The power plug serves as a circuit breaker and must be plugged into a socket with protected contacts.
- Only use the supplied original power cord. Do not use an inadequately measured replacement.
- Place the furnace on a fire-proof table. Observe local regulations (e.g. distance to combustible substances or objects, etc.).
- Always keep the air vents at the rear and the side of the furnace free from obstruction.
- Do not touch any parts that become hot during the operation of the furnace. There is a burn hazard.
- When removing hot components from the firing chamber (e.g. firing table, firing tray), make sure not to place them on a flammable surface!
- Clean the furnace only with a dry, soft cloth. Do not use any solvents! Disconnect power before cleaning and allow the furnace to cool down!
- The furnace must be cool before it is packed for transportation purposes.
- Use original packaging for transportation purposes.
- Before calibration, maintenance, repair or change of parts, the power must be disconnected and the furnace has to be cool if it has to be opened.
- If calibration, maintenance or repair has to be carried out with the power connected and furnace open, only qualified personnel who are familiar with the risks and dangers may perform these procedures.
- After maintenance, the required safety tests (high voltage resistance, protective conductor, etc.) have to be carried out.
- Ensure that only fuses of the indicated type and rated current are used.
- If it is assumed that safe operation is no longer possible, the power must be disconnected to avoid accidental operation. Safe operation is no longer possible if
 - the furnace is visibly damaged;
 - the furnace does not work;
 - the furnace has been stored under unfavourable conditions over an extended period of time.
- Use only original spare parts.
- The temperature range for faultless operation is +5 °C to + 40 °C.
- If the furnace has been stored at very low temperatures or high atmospheric humidity, the head has to be opened and the furnace dried or left to adjust to room temperature for approx. 4 hours (do not connect the power yet).
- The furnace has been tested for use at altitudes of up to 2000 m above sea level.
- The furnace may only be used indoors.
- Before leaving the factory, the furnace functions were tested for several hours. It is therefore possible that these tests have caused slight discolouration of the insulation. Nevertheless, your Programat P310 G2 is still a brand new furnace.



Any disruption of the protective conductor either inside or outside the furnace or any loosening of the protective conductor may lead to danger for the user in case of malfunction. Deliberate interruptions are not tolerated.



Materials developing harmful gases must not be fired!

Warnings regarding the dismantling of the heating muffle



This product contains ceramic fibres and may release fibre dust. Fibre dust has proved to be carcinogenic in animal experiments. The heating muffle may only be dismantled by a qualified After Sales Service Centre. Information regarding the Safety Data Sheet is also available from your After Sales Service Centre.

Disposal:



The furnaces must not be disposed of in the normal domestic waste. Please correctly dispose of old furnaces according to the corresponding EU council directive. Information regarding disposal may also be found on the respective national Ivoclar Vivadent homepage. The packaging may be discarded with the regular household refuse.

3. Product Description

3.1 General aspects

The Programat P310 G2 is a modern ceramic furnace for dental applications. The firing chamber may be heated up to max. 1200 °C by means of a heating element. Furthermore, the firing chamber has been designed in such a way that a vacuum may be created with a vacuum pump. Electronic components with the corresponding software monitor and control the firing programs. Additionally, the set and actual temperatures are continuously compared.

The Programat P310 G2 consists of the following components:

- Furnace base with electronic controls
- Furnace head with firing chamber
- Cooling tray
- Firing table
- Power cord and hose for vacuum pump

3.2 Hazardous areas and safety equipment

Description of the hazardous areas of the furnace:

| Hazardous area | Type of risk |
|---------------------------|--------------------------|
| Firing chamber | Burn hazard |
| Opening/closing mechanism | Risk of crushing |
| Electrical components | Risk of electrical shock |

Description of the safety equipment of the furnace:

| Safety equipment | Protective effect |
|------------------------------|--|
| Protective conductor | Protection from electrical shock |
| Electrical fuses | Protection from electrical shock |
| Furnace housing and end caps | Protection from electrical shock, burning and crushing |

4. Installation and Initial Start-Up

4.1 Unpacking and checking the contents

Remove the furnace components from their packaging and place them on a suitable table. Please observe the instructions on the outer packaging.

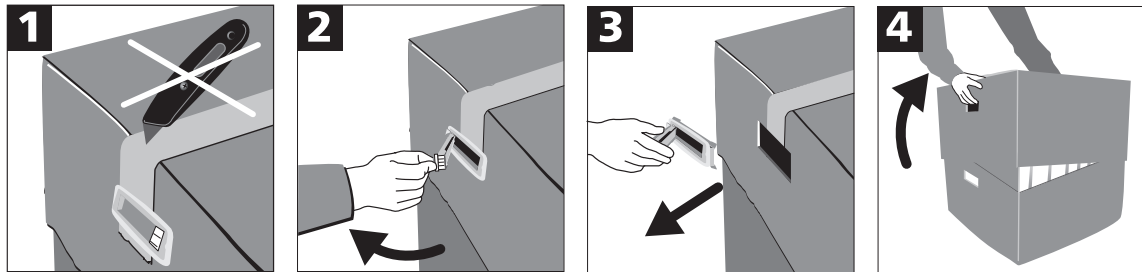

There are no special transportation grips on the furnace. Support the bottom of the furnace to carry it. Check the delivery for completeness (see delivery form in Chapter 9) and transportation damage. If parts are damaged or missing, contact your local Ivoclar Vivadent Service Centre.



We recommend keeping the original packaging for future service and transportation purposes.

4.2 Selecting the location

Place the furnace on a flat table using the furnace feet. Make sure that the furnace is not placed in the immediate vicinity of heaters or other sources of heat. Make sure that air may properly circulate between the wall and the furnace. Also ensure that there is enough space between the furnace and the user, as the furnace releases heat during the opening of the furnace head.

The furnace should neither be placed nor operated in areas where there is an explosion hazard.

4. Installation and Initial Start-Up

4.3 Assembly

Assembling the furnace is very easy and involves only few steps. Before you start assembling the furnace, make sure that the voltage indicated on the rating plate (27) complies with the local power supply. If this is not the case, the furnace must not be connected.

Step 1:

Mounting the cooling tray (7)

Remove the two screws for the cooling tray (8).

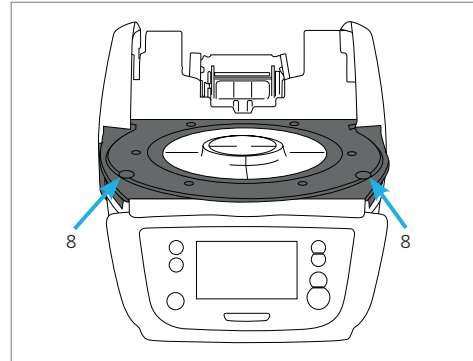

Place the cooling tray (7) on the frame plate (19). Make sure that the cooling tray is correctly positioned.

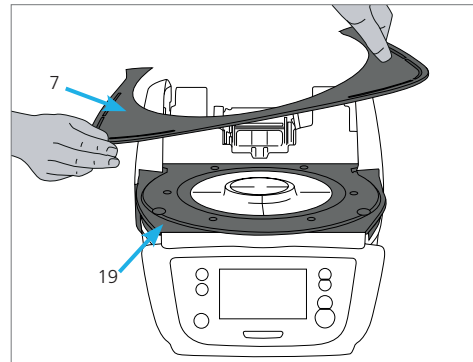

Secure the cooling tray (7) with the two screws (8).

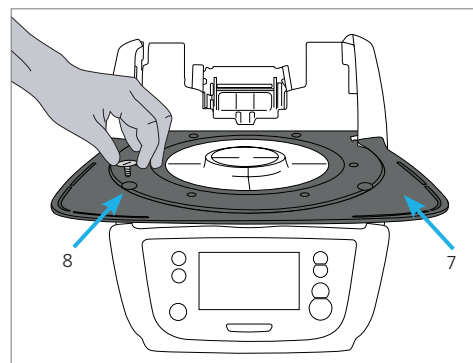

Step 2:

Placing the firing plate

Place the firing plate (17) on the frame plate (18). If placed correctly, the bottom side of the firing plate automatically centres on the frame plate.

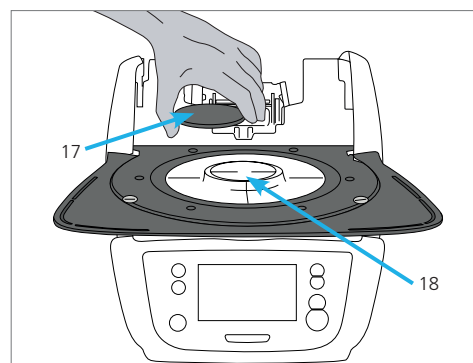

Step 3:

Mounting the furnace head

The complete furnace head is best mounted with the rear panel of the furnace pointing towards the user. Lift the furnace head with both hands (see picture) and carefully position it on the furnace head mounting.

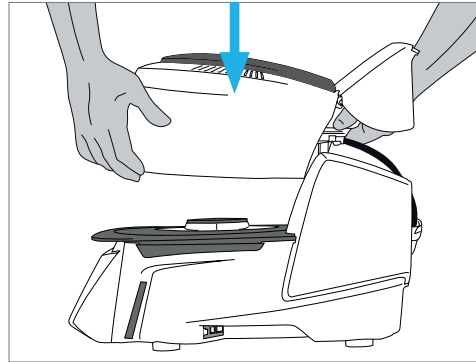

Position the furnace head mounting as shown in the picture until the furnace head audibly snaps into place. Make sure that the firing plate or the insulation is not damaged by mounting the furnace head.

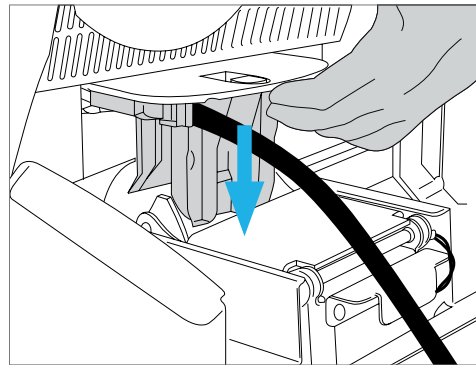

Step 4:

Connections

Connect the cables of the furnace head with the furnace base. Proceed as follows:

- Connect the vacuum hose (48).
- Insert the thermocouple plug (46). (Make sure that the polarity of the plug is correct.)
- Insert the heater plug (44).

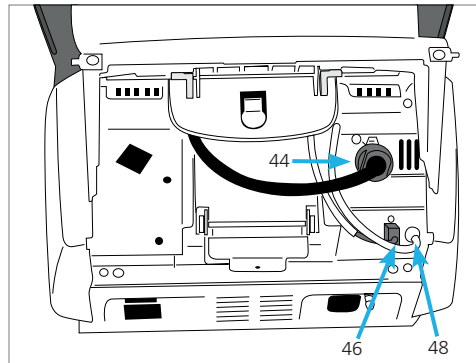

1. Insert the heater plug in the intended socket.
2. Secure the heater plug by rotating it 45° until it sn

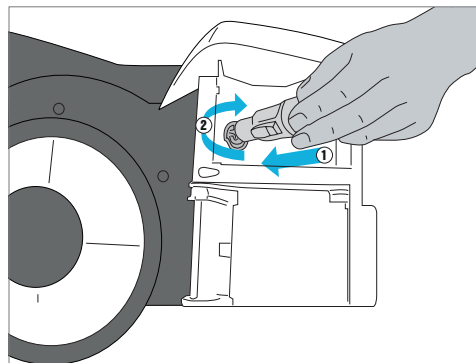

4. Installation and Initial Start-Up

Step 5:

Mounting the hood

Once all cables are properly connected to the furnace base, close the hood (11) over the connections.

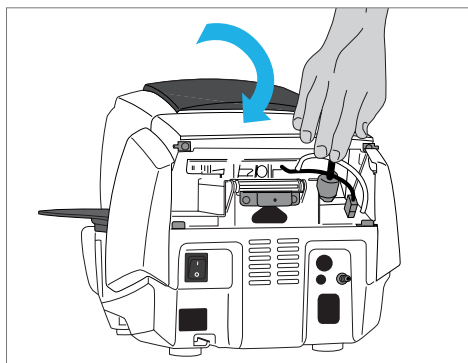

Step 6:

Mounting the connection cover

Mount the connection cover (32) and secure it with the fastening screw (33). Make sure that the lateral catch springs snap into place when mounting the connection cover.



The furnace may only be operated with the hood and the connection cover mounted!

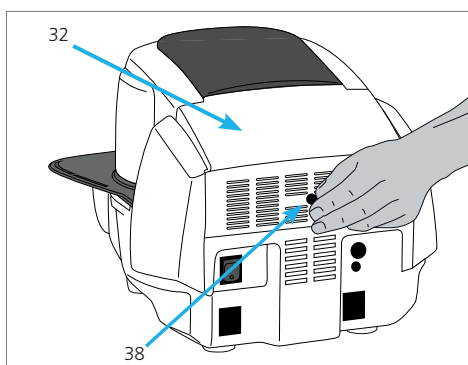

Step 7:

Establishing additional connections

Power connection

Please make sure that the voltage indicated on the rating plate complies with the local power supply. Subsequently, connect the power cord (26) with the power socket of the furnace (25).



The furnace may only be operated with the supplied power cord.

Vacuum pump connection

Connect the vacuum pump plug (30) with the vacuum pump socket (29). We recommend using only a vacuum pump from Ivoclar Vivadent, since these pumps are especially coordinated with the furnace. If other pumps are used, please observe and do not exceed the maximum power consumption.



Do not shorten the vacuum hose! The minimum length of the vacuum hose is 1.6 m.

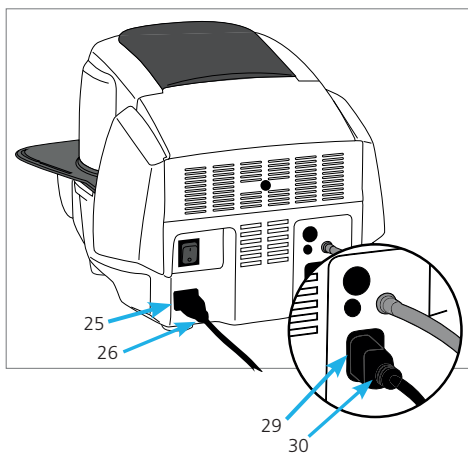

Creating a LAN connection

In order to use the IoT function, you need a LAN connection to your web-enabled local PC network. Use the LAN network cable included in the delivery for this purpose. Connect one plug to the ethernet port (15) and the other one to the router (RJ45).

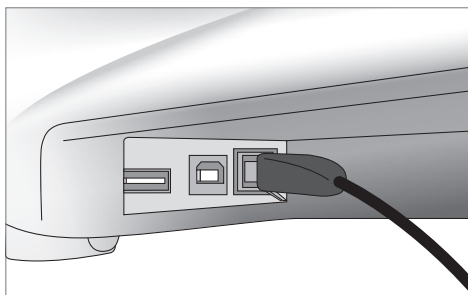

4.4 Removing the furnace head

Before the hood and the connection cover are removed, the furnace has to be switched off and the power cord disconnected from the power socket.

1. Loosen and remove the knurled screw (33) of the connection cover (32).
2. Dismount the connection cover (32).
3. Open the hood (11).
4. Release the heater plug (44) and disconnect it with a 45° anti-clock-wise rotation.
5. Disconnect the thermocouple plug (46).
6. Disconnect the vacuum hose (42).
7. Press the leaf spring (39) with a finger, lift off the furnace head at the same time and remove it.



Make sure the furnace head has completely cooled down before it is removed (fire hazard).

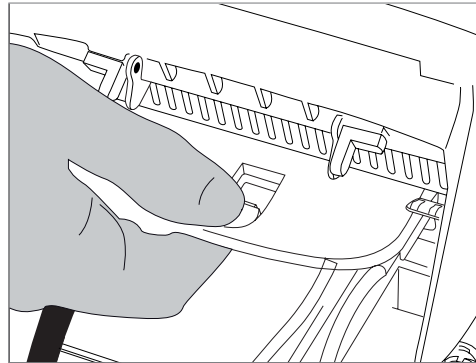

4.5 Initial start-up

1. Connect the power cord with the wall socket.
2. Put the On/Off switch (24) at the rear of the furnace on position I.

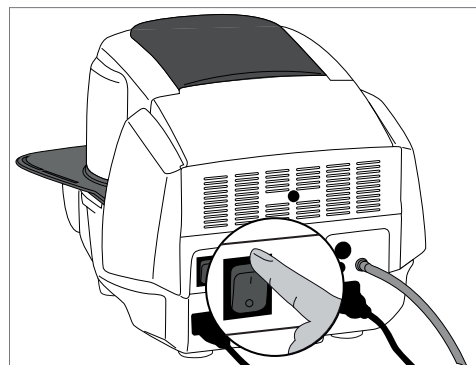

4.5.1 Start screen with QR code for video tutorials

The QR code on the splash screen can be scanned with a mobile device (e.g. a smartphone). This will take you directly to the Programat Video Tutorials homepage, where you can watch videos on different topics.



4. Installation and Initial Start-Up

4.5.2 Basic settings upon initial start-up

Upon the initial start-up of the new furnace, a number of basic settings are required. These settings will be stored and will not appear anymore upon the following starting procedure.

Step 1:

Select the language.

The first setting is the language selections. The touch buttons (display keys) can be operated by tapping the display.



Select the desired language using the **[Arrow up / down]** buttons. Confirm the entry with the green button. The **[Next]** button is used to reach the next entry screen.

Step 2:

Select the desired temperature unit.

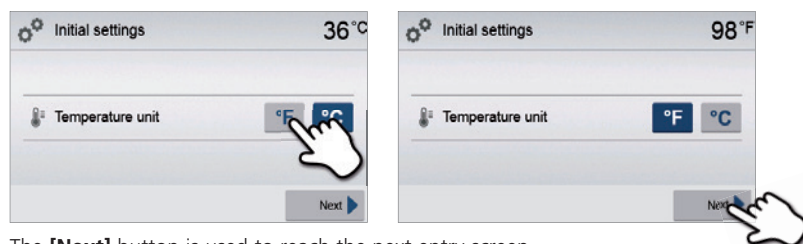

The **[Next]** button is used to reach the next entry screen.

Step 3:

Set the time zone (UTC).

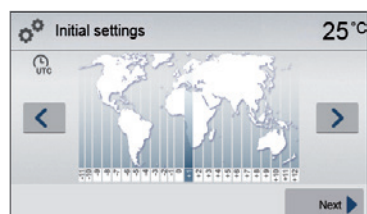

The time zone can be changed by pressing the **[Left]** and **[Right]** buttons. Use the **[Next]** button to confirm the selection and reach the next entry screen.

Step 4:

Set the time (hours, minutes, seconds).

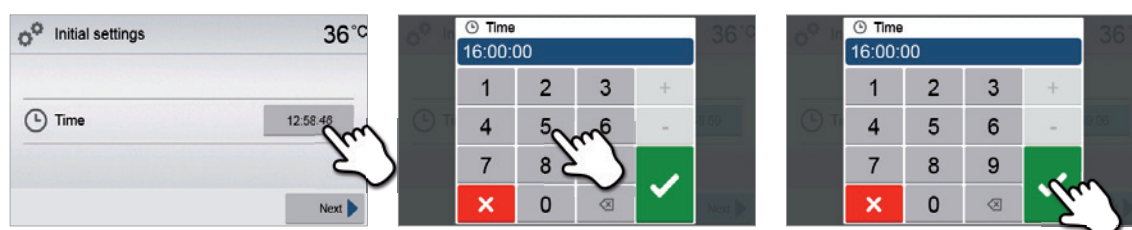

Confirm the entry with the green button. The **[Next]** button is used to reach the next entry screen.

Step 5:

Select the date format.

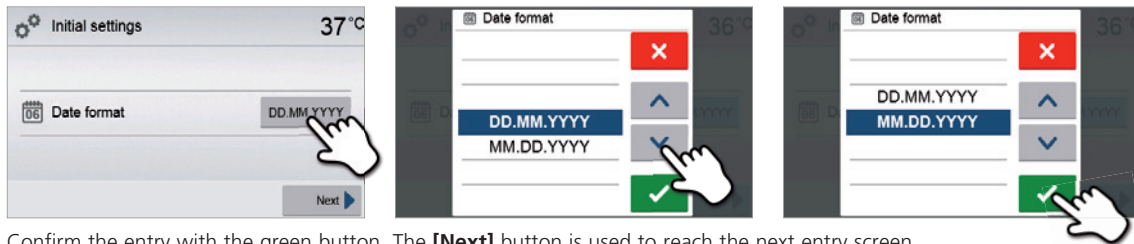

Confirm the entry with the green button. The **[Next]** button is used to reach the next entry screen.

Step 6:

Set the date (day, month, year).

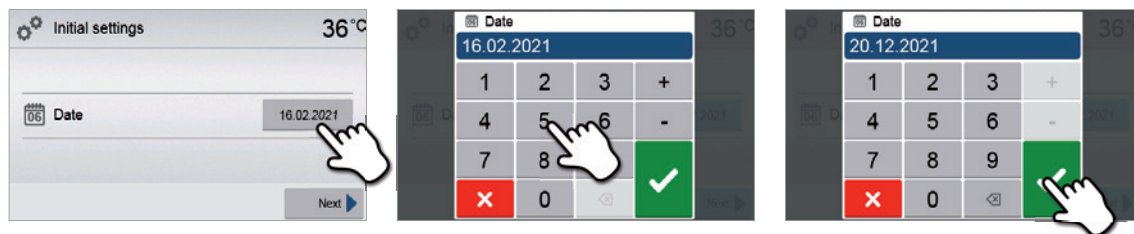

Confirm the entry with the green button. The **[Next]** button is used to reach the next entry screen.

Step 7:

Confirm the privacy policy

More information about the privacy policy can be found at <http://www.ivoclarvivadent.com/digitalservices>



The **[Next]** button is used to reach the next entry screen.

The initial start-up and entry of the basic settings are now complete. The furnace will now automatically conduct a self-test.

4. Installation and Initial Start-Up

4.5.3 Start screen and self-test

Immediately after switching on, the display shows the start screen for a few seconds. Subsequently, the furnace conducts an automatic self-test. The performance of all furnace components is automatically checked.

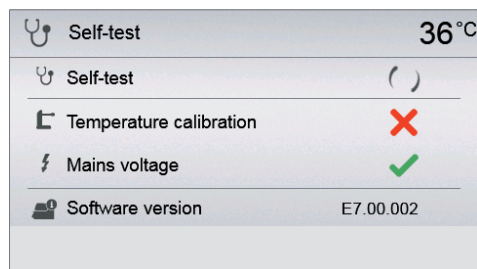

The following information is displayed:

| Information | Icon | Description |
|-------------------------|------|--|
| | ⦿ | Automatic self-test in progress. The furnace is checking the function of the furnace components. |
| Self-test | ✓ | The self-test was successful. No malfunctions were found. |
| | ✗ | The self-test was not successful. Please note the error message on the display. |
| Temperature calibration | ✓ | Temperature calibration of the furnace is not required. |
| | ✗ | Some time has passed since the last calibration. Please conduct a calibration procedure. |
| Power supply | ✓ | The power supply voltage is in the acceptable range. |
| | ✗ | The power supply is outside the acceptable range. |
| Software version | | The currently installed software version is displayed. |

If the self-test has been successful, the furnace will automatically display the home screen.

If the program recognizes a malfunction during the test, a corresponding error message with the corresponding rectification information appears on the display.

The acoustic signal and the error message can be acknowledged with the corresponding buttons.

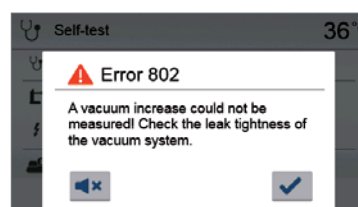

Press the **[Next]** button to confirm the self-test.

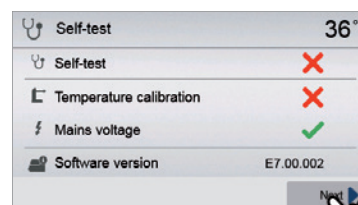

Before the first firing, the firing chamber should be dehumidified using the dehumidification program (see Chapter 5.3 for details).



Please note that the furnace may require a certain acclimation time after it has been set-up. Particularly if the furnace was exposed to considerable temperature differences (water condensation).

5. Operation and Configuration

5.1 Introduction to the operation

5.1.1 Control unit





The Programat P310 G2 is equipped with a widescreen colour display. The furnace can be intuitively operated by means of the membrane-sealed keypad and the touch screen. The touch buttons can be actuated by slightly tapping the display with the fingertip and the furnace runs the desired function.



The user interface in the display is divided into three sections:

1. **Information bar** (e.g. indication of the current furnace temperature, selected program type, etc.)
2. **Main screen** (e.g. editing firing programs, changing the settings, etc.)
3. **Navigation bar** (e.g. scrolling, scrolling to higher levels, etc.)

5.1.2 Explanation of key functions

| Key | Function |
|---|---|
|  | Home Switch to home screen (main menu). |
|  | Program key Press once: Display of the currently selected program. Press twice: Switch to the program selection via number entry. |
|  | Power-saving key Power-saving function activated (only possible with the furnace head closed and the furnace on idle). The display shows the power-saving icon. Pressing any key ends the power-saving function. |
|  | Open furnace head Quick cooling with the furnace head open: If the furnace head is completely open and the OPEN FURNACE HEAD key is pressed again, the quick cooling function is activated, e.g. the vacuum pump is switched on for 5 minutes. This function can be stopped at any time by pressing the STOP, CLOSE FURNACE HEAD or START key. This function can be activated any time when the furnace head is open. |
|  | Close furnace head |

5. Operation and Configuration

| | |
|--|---|
| | <p>STOP</p> <p>A program in progress can be paused by pressing the STOP key and stopped by pressing STOP twice. Movement of the furnace head can be stopped at any time by pressing STOP. The acoustic signal can be confirmed by pressing the STOP key.</p> |
| | <p>START (LED Start)</p> <p>Starts the selected program. The green LED indicates that a program is active. If the program is paused (1x STOP), the Start LED flashes until renewed pressing of START results in the program being resumed.</p> |

5.1.3 Explanation of the most important touch buttons

| Button | Function |
|--------|---|
| | <p>Scroll left / Scroll right</p> <p>With these buttons, for example, you can scroll to page 2 of the home screen.</p> |
| | <p>Back with note</p> <p>With this button, you can change to the "next higher" menu level. The button indicates to which screen you change, e.g. to the home screen.</p> |
| | <p>Close</p> <p>With this button, you can leave sub-menus. You change to the "next higher" menu level.</p> |
| | <p>Confirm your entries</p> <p>This button is used to confirm an entry. If the button appears pale green, no entry has been made yet or the value entered is not in the acceptable range.</p> |
| | <p>Cancel entry</p> <p>The entry can be cancelled with this button; changed values are not saved.</p> |
| | <p>Program parameter buttons</p> <p>Pressing these buttons allows you to change program parameters. A selection list or numeric pad for entering the values appears. The upper half of the button itself shows the parameter in question (e.g. closing time), while the lower half shows the entered value (e.g. 00:18).</p> |
| | <p>On/Off button</p> <p>This button is used to switch functions on or off.</p> |
| | <p>Parameter buttons</p> <p>Pressing these buttons results in a selection list or numeric pad for entering the values to appear.</p> |

5.1.4 Explanation of the numeric pad and selection list

– Numeric pad

The numeric pad enables the entering and changing of parameters, e.g. in firing programs or set-up menus. Additionally, the currently set value is indicated, as well as the minimum and maximum values.

An entry must be confirmed with the green button. As soon as the entry has been confirmed, the numeric pad is closed. If the button appears pale green, the value is not in the acceptable range.

The numeric pad can be closed with the red button, without any parameters being changed.



– Selection list

In the selection list, the desired parameter can be selected by using the up/down arrows. An entry must be confirmed with the green button. After that, the selection list is closed.

The selection list can be closed with the red button, without any parameters being changed.

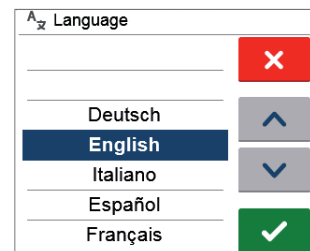

5.1.5 Explanation of the home screen

After the furnace is switched on, the display shows the home screen. All functions of the Programat can be selected from this screen. You can switch back to the home screen with the HOME key.

By pressing a selection button, you will reach the corresponding menu (e.g. firing programs, settings, calibration, etc.).

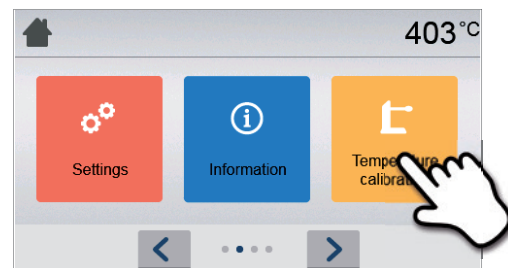

The next page of the home screen can be accessed with the arrow buttons, where additional functions are available.

The circles between the arrows indicate the number of pages. The current page is marked with a light dot.

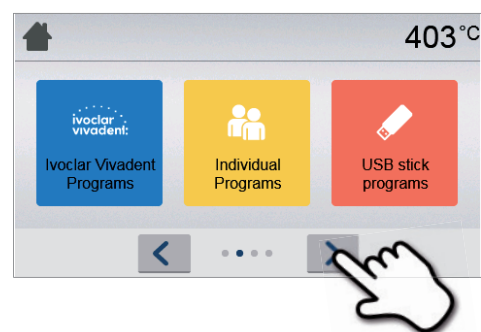

5. Operation and Configuration

5.1.6 Explanation of the speaker signals

– **Upon closing the furnace head below 100 °C**



There is a risk of crushing upon closing the furnace head. Upon closing below 100 °C, the user is alerted to the hazard by an acoustic signal.

– **Upon completion of the self-test**

To inform the user that the automatic self-test has been successfully completed, a pre-set, not modifiable melody is played.

– **Furnace head open and temperature below 560 °C**

To inform the user that the temperature in the open furnace head has dropped below 560 °C, the selected melody is played (5 seconds). This is the earliest possible time to remove an object from the furnace. (The removal temperature depends on the material used. Please refer to the corresponding Instructions for Use.)

– **Furnace head open and temperature below 360 °C**

To inform the user that the temperature in the open furnace head has dropped below 360 °C, the selected melody is played. If the first playback (10 seconds) is not acknowledged with the STOP key, a second playback sounds after 5 minutes (for 5 minutes) to signal that the furnace head is cooling down. After that, no further signal is played. If one of the two playbacks is acknowledged with the STOP key, the signal transmitter is switched off and no further signals will be sounded.

– **For error messages**

Error messages are acoustically supported with the “error melody” (endless beep). The signal transmitter may be switched off with the STOP key, while the error message still remains visible. If the error message is acknowledged with the corresponding button, the signal transmitter is also switched off.

5.1.7 Optical Status Display (OSD)

The Optical Status Display (OSD) (6) shows the most important statuses of the furnace. The following activities are indicated:

| Colour | Activities |
|-------------------|---|
| Yellow | The furnace is performing the self-test or is not ready for use, as the recommended temperature range for a program start has not yet been reached. |
| Yellow (flashing) | Information, note or error message |
| Green | The furnace is ready for use; the currently selected program can be started. |
| Red | A program is active. |

5.1.8 User code



For safety reasons, a user code is required for certain settings. The user code ex factory is as follows:

1234

The user code can be individually changed. See Chapter 5.3 Settings for details.

5.2 Firing programs and programming options

5.2.1 Program structure

The furnace offers several types of programs:

- a. Programs for Ivoclar Vivadent materials
- b. 300 free, individually adjustable programs
- b. 300 free, individually adjustable programs on a USB stick

The program types are subdivided into program groups. Each program group consists of 20 programs.

All programs are equivalent and therefore full-fledge programs. For each program, all the parameters can be adjusted.

a) Programs for Ivoclar Vivadent materials (see enclosed Program Table)

When the furnace is delivered ex factory, the Ivoclar Vivadent programs already contain the recommended material parameter settings and are write-protected. Consequently, it is not possible to accidentally overwrite the programs.

If required, however, the parameters can be changed and overwritten at any time, if the programs are to be used for other purposes. Therefore, these programs are also available as individual programs.



In case of software updates, individually changed parameters in Ivoclar Vivadent programs might be reset to the factory settings or changed!

b) Free, individually adjustable programs

The programs are designed in such a way that they can be either used as conventional, one-stage programs, or as two-stage programs, if required. The programs and program groups can be individually named.



In case of software updates, individually changed parameters in free programs are **NOT** reset to the factory settings or changed!

c) Free, individually adjustable programs on a USB stick

In a first step, a USB stick must be prepared as program memory (see Chapter 5.3). The programs are designed in such a way that they can be either used as conventional, one-stage programs, or as two-stage programs, if required. The programs and program groups can be individually named.



In case of software updates, individually changed parameters in free programs are **NOT** reset to the factory settings or changed!

5. Operation and Configuration

5.2.2 Program selection

The program selection requires only few steps:

1. Select program type.

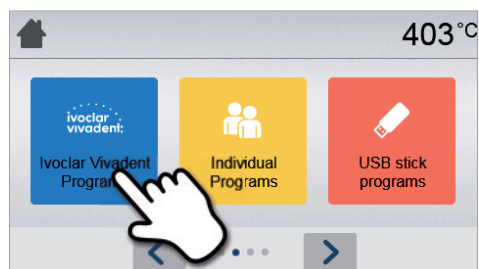

2. Select program group.

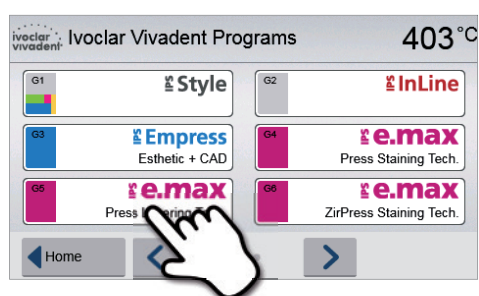

3. Select the program.

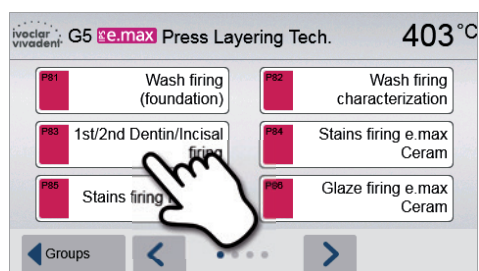

4. Start program or edit program parameters.

The firing program can now be started or, as an alternative, the program parameters can be changed.

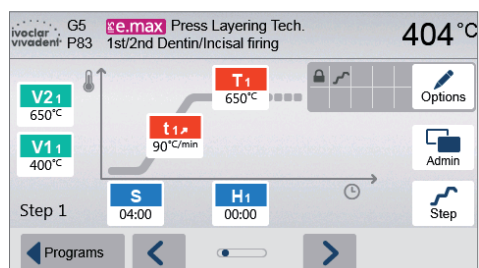

Quick program selection

Pressing the P key switches to the program screen of the current program. When the program screen is shown, pressing the P key again switches to the quick program selection by means of number entry.

Browsing the programs

If a program has been selected, the neighbouring programs can be accessed by pressing the **[Arrow]** buttons.

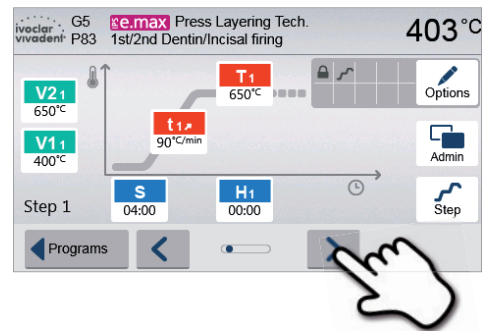

5.2.3 Program screen / Editing programs

If a program has been selected, the program screen is displayed. The firing programs can be changed or edited in this screen.



For Ivoclar Vivadent programs, the write-protection must be deactivated first before any parameters can be changed.

The following information is displayed:

1. Information bar:

- Program designation
- Current furnace temperature

2. Firing curve

- Closing time, holding time
- Temperature increase rate, holding temperature, long-term cooling
- Vacuum on, vacuum off

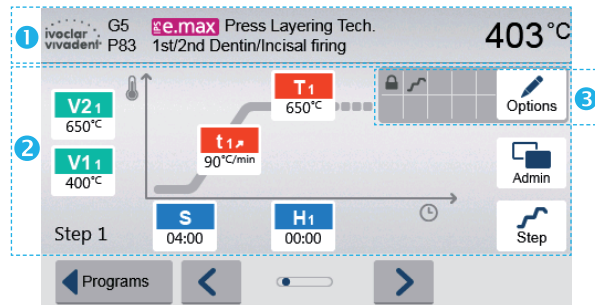

3. Program options:

In addition to the parameters shown in the firing curve, several other options are available that can be activated by pressing the **[Options]** button. The icons in the grid show the activated options.

Editing parameters

Parameters are entered or edited in two steps.

Example: Setting the holding temperature

1. Press the **[T]** button.

Changing program options



2. Enter the desired holding temperature and confirm with the green button.

The holding temperature has been successfully changed. All other parameters shown in the firing curve can be changed / edited in the same way.

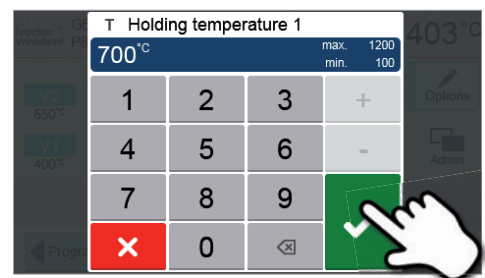

5. Operation and Configuration

Pressing the **[Options]** button opens the menu for advanced program options:

Example 1: Deactivating the write-protection

1. Press the **[Options]** button.

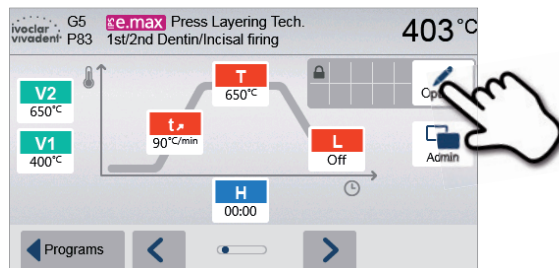

2. Press the **[Deactivate write-protection]** button.

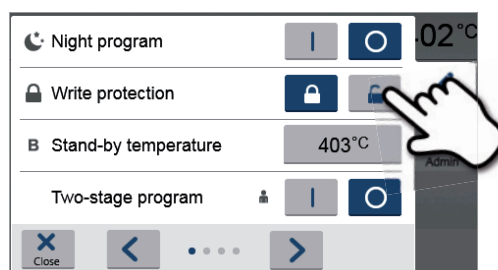

3. Press the **[Return]** button to leave the Options menu.

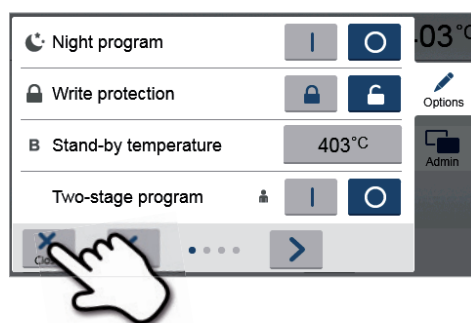

4. The write-protection was successfully deactivated

The lock symbol is no longer shown on the display next to the **[Options]** button.

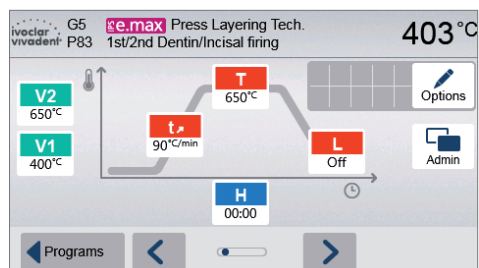

Example 2: Changing the predrying temperature

1. Press the [Options] button.

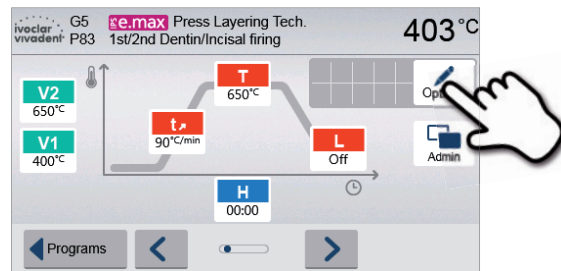

2. Scroll to the next page in the Options menu.

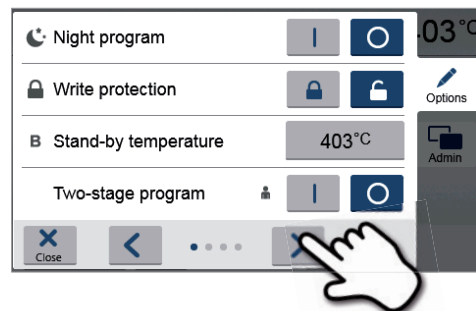

3. Press the [Predrying temperature] button.

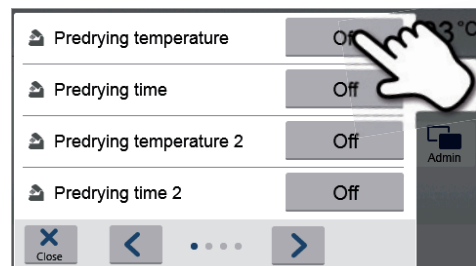

4. Enter the desired predrying temperature and confirm with the green button.

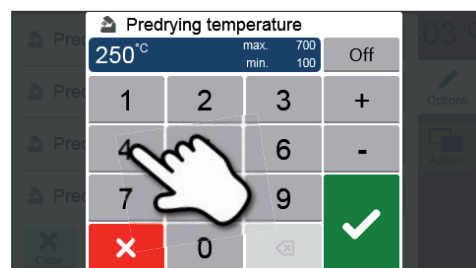

5. The predrying temperature was successfully changed.

Press the [Close] button to leave the Options menu.

The program screen now shows the symbol "predrying active" next to the [Options] button.

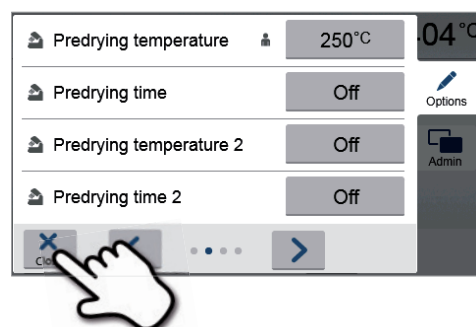

5. Operation and Configuration

Two-stage programs

A two-stage program permits firing procedures on two temperature levels with different parameters (e.g. Holding time Stage 1, Holding time Stage 2) to be conducted.

The function "two-stage program" can be selected in the Options menu.

If a two-stage program has been activated, switching back and forth between the parameters of the first temperature level and the second temperature level is possible in the program screen. The screen now shows the symbol "two-stage program active" next to the **[Options]** button.

Example:

1. Changing the program stage

The program screen shows the parameters of the first temperature level (S, H1, etc.).

Pressing the **[Step]** button results in the screen for the second temperature level being displayed.

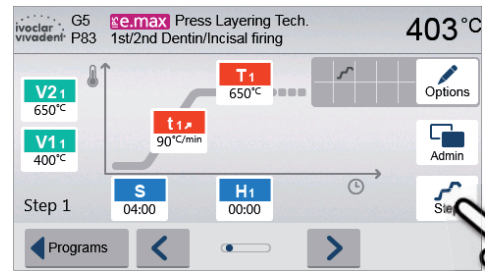

2. Now, the parameters for the second temperature level can be entered.

Pressing the **[Step]** button again switches the screen back to the first temperature level.

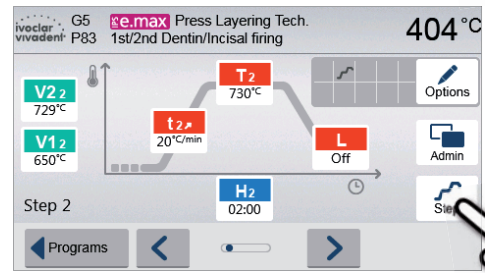

Automatic plausibility check of the parameters

The furnace is equipped with an automatic plausibility check function. The parameters are checked upon each program start. In case of contradictory parameter combinations, the program stops automatically and the respective information is indicated.

5.2.4 Adjustable parameters in the program screen

| | |
|------------------------|---|
| S | <p>S – Closing time The closing time controls the duration of the furnace head closing process. <i>Value range: 00:18–30:00 (mm:ss)</i></p> |
| t / | <p>t – Temperature increase rate (for two-stage programs: t_1) The temperature increase rate defines by how many degrees per minute the furnace heats up. <i>Value range °C: 10–140 °C/min; Value range °F: 18–252 °F/min</i></p> |
| T | <p>T – Holding temperature (for two-stage programs: T_1) The holding temperature defines the temperature at which a firing process is conducted. <i>Value range °C: 100–1200 °C; Value range °F: 212–2192°F</i></p> |
| H | <p>H – Holding time (for two-stage programs: H_1) The holding time indicates how long an object is fired at the holding temperature. <i>Value range: 00:00–60:00 (mm:ss)</i></p> |
| V1 | <p>Vacuum on (for two-stage programs: $V1_1$) The parameter defines the temperature at which the vacuum is activated. <i>Value range °C: OFF or 1–1200 °C; Value range °F: 0 or 34–2192 °F</i></p> |
| V2 | <p>Vacuum off (for two-stage programs: $V2_1$) The parameter defines the temperature at which the vacuum is deactivated.</p> <ul style="list-style-type: none"> • Holding time without vacuum: If V2 is set one degree lower than the holding temperature, the vacuum is ended before the holding time. • Holding time with vacuum: If V2 corresponds to the holding temperature, the vacuum is maintained during the entire holding time. • Long-term cooling with vacuum: If V2 is set one degree higher than the holding temperature, the vacuum is maintained during long-term cooling. <p><i>Value range °C: OFF or 1–1200 °C; Value range °F: 0 or 34–2192 °F</i></p> |
| L | <p>Long-term cooling If long-term cooling is activated, the furnace cools to the set temperature (L) at the end of the holding time with the furnace head closed. <i>Value range °C: OFF or 50–1200 °C; Value range °F: 0 or 122–2192 °F</i></p> |
| t_L | <p>Cooling rate Can only be set if long-term cooling “L” is activated. The cooling rate defines by how many degrees per minute the furnace cools down. <i>Value range °C: OFF or 1–50 °C/min; Value range °F: OFF or 2–90 °F/min</i></p> |
| t₂ / | <p>t₂ – Temperature increase rate Stage 2 This parameter defines for the second temperature level by how many degrees per minute the furnace heats up. <i>Value range °C: 10–140 °C/min; Value range °F: 18–252°F/min</i></p> |
| T₂ | <p>T₂ – Holding temperature Stage 2 The holding temperature for the second temperature level defines the temperature at which a firing process is conducted. <i>Value range °C: 100–1200 °C; Value range °F: 212–2192 °F</i></p> |
| H₂ | <p>H₂ – Holding time Stage 2 The holding time for the second temperature level indicates how long an object is fired at the holding temperature. <i>Value range: 00:00–60:00 (mm:ss)</i></p> |
| V1₂ | <p>Vacuum on Stage 2 The parameter defines the temperature at which the vacuum for the second temperature level is activated. <i>Value range °C: OFF or 1–1200 °C; Value range °F: 0 or 34–2192 °F</i></p> |
| V2₂ | <p>Vacuum off Stage 2 The parameter defines the temperature at which the vacuum for the second temperature level is deactivated. If V2₂ corresponds to the holding temperature, the vacuum is maintained during the entire holding time. <i>Value range °C: OFF or 1–1200 °C; Value range °F: 0 or 34–2192 °F</i></p> |

5. Operation and Configuration

5.2.5 Adjustable parameters in the Options menu

In addition to the parameters shown in the firing curve, several other options are available that can be activated by pressing the **[Options]** button. Active options are shown in the grid next to the **[Options]** button.

The following firing program options are available:



Night program

If this function is active, the furnace head remains open after the firing process and the heater is switched off. No acoustic signals are sounded. Once the temperature drops below 100 °C, the furnace head closes, the heater remains switched off and the furnace cools down to room temperature.

Advantages of the night function:

After a power failure, the night program is always resumed. The program is resumed at the position, at which the power failure occurred. After a longer power failure, the furnace head does not heat up to stand-by temperature and the object is protected at room temperature with the furnace head closed.

If the night program function is switched on, it is active only for the next program cycle.

Setting options: On/Off



Program write-protection

If the program write-protection is activated, the program parameters and program options cannot be changed. This is to prevent accidental changes to the program.

Setting options: On/Off



Stand-by temperature

The stand-by temperature is the temperature to which the furnace heats up immediately after switching on. The temperature is maintained with the furnace head closed and when no firing process is active.

Programat furnaces are programmed to a stand-by temperature of 403 °C in the factory. The temperature can be individually set for each program.

Value range °C: 100–700 °C; Value range °F: 212–1292 °F



Two-stage programs

If this function is activated, the selected program can be programmed on two temperature levels.

Setting options: On/Off



Predrying temperature Stage 1

In a program with activated predrying in Stage 1, the desired “predrying temperature” is reached (heating or cooling) after the start with the furnace head open. Once this temperature is reached, predrying is conducted during the “predrying holding time”. Once this time has elapsed, the furnace closes within the desired closing time.

The predrying temperature for Stage 1 can be set as follows:

Value range °C: OFF or 100–700 °C; Value range °F: OFF or 212–1292 °F



Predrying holding time Stage 1

This parameter defines the duration of the predrying process for Stage 1 once the desired predrying temperature has been reached.

Value range OFF or 00:00–60:00 (mm:ss)



Predrying temperature Stage 2

Predrying for Stage 2 is only available if Stage 1 has also been activated. The parameters are set in the same way. At this stage, the furnace head is half open.

Value range °C: OFF or 100–700 °C; Value range °F: OFF or 212–1292 °F



Predrying holding time Stage 2

This parameter defines the duration of the predrying process for Stage 2 once the desired predrying temperature has been reached.

Value range OFF or 00:01–60:00 (mm:ss)

TSP

Thermo Shock Protection (TSP)

The TSP function protects your dental-lab work during the closing process. For this purpose, TSP gauges the temperature of the firing chamber in the furnace head upon the start of the firing program. If required, the closing path within the set closing time S is adjusted.

Setting options: On/Off



Pre-vacuum

If a firing program is conducted with pre-vacuum, the vacuum pump is switched on at the end of the closing time (as soon as the furnace head is closed) and run until the pre-vacuum time has elapsed. The heating phase begins after the pre-vacuum time is over.

The value V1 is ignored upon the start of a program with individually activated pre-vacuum. The vacuum remains switched on until V2 is reached. V2 must be higher than the stand-by temperature B.

Setting options: OFF or 01:00–05:00 (mm:ss)

Hv

Vacuum holding time

With this function, the vacuum share of the holding time can be individually set.

Example: H (Holding time) = 02:00 (mm:ss); if a vacuum share of 50% is desired, the parameter "Vacuum holding time (Hv)" has to be set to 01:00 (mm:ss).

Setting options: OFF or 00:01–60:00 (mm:ss)



Quick opening of the furnace head

If the option "Quick opening of the furnace head" is activated, the furnace head opens at maximum speed at the end of the holding time.

Setting options: On/Off



Extraction system

If this function is activated, any vapours are extracted during the closing process by means of the vacuum pump.

Setting options: On/Off



IoT function

The IoT function can be activated and deactivated here. Moreover, the connectivity status is indicated. In addition, the time zone can be set in this section.

5. Operation and Configuration

5.2.6 Starting and stopping programs / the operating indicator

Once the program is started by pressing START, the firing curve display appears.

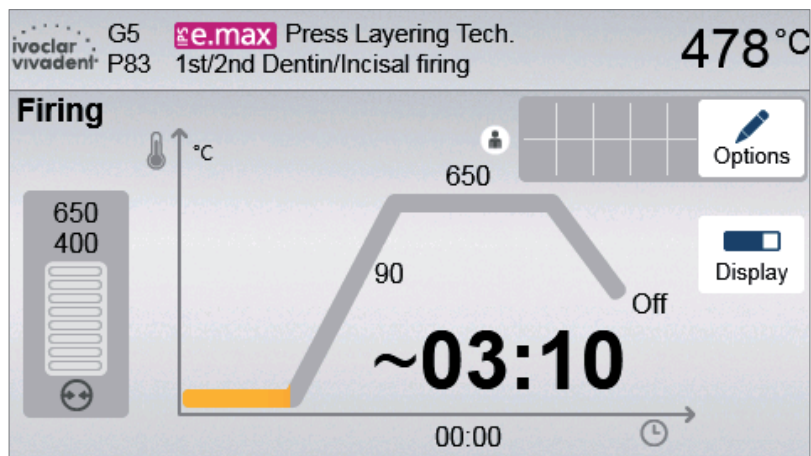

The following information is displayed:

– Information bar

The information bar in the upper margin of the display, program name and the current furnace temperature are indicated.

– Main area

The vacuum is shown on the left side of the main screen. The progress of the program is shown in the form of a firing curve. The estimated remaining time is also displayed in 10-second intervals. If no vacuum is activated, the vacuum indicator and all the corresponding parameters are blank.

The process status is shown in colour in the firing curve:

- Orange: Program is closing the furnace head or is in predrying mode.
- Red: Program is heating up or is in holding time mode.
- Blue: Program is in long-term cooling or is opening the furnace head.

Active firing program options are shown in the grid next to the **[Options]** button.

If a two-stage program is selected, the firing curve is shown in two stages.

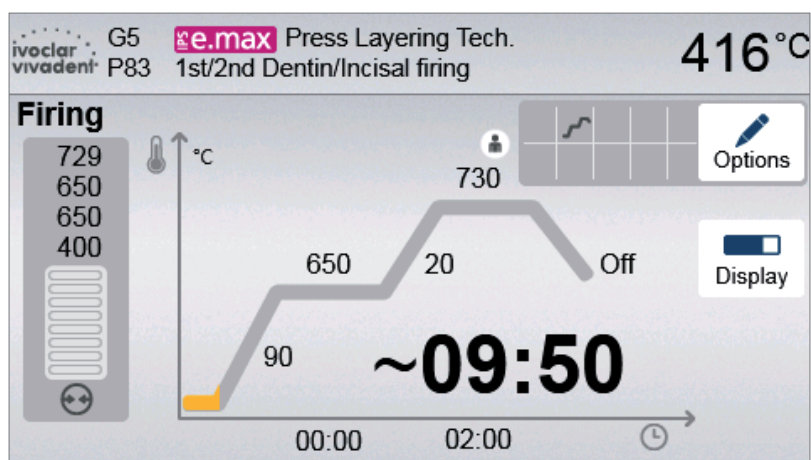

Changing the operating indicator

The active firing program can be displayed in two ways:

- Operating indicator “firing curve”
- Operating indicator “remaining time”

If the **[Display]** button is pressed during an active program, the operating indicator can be switched.

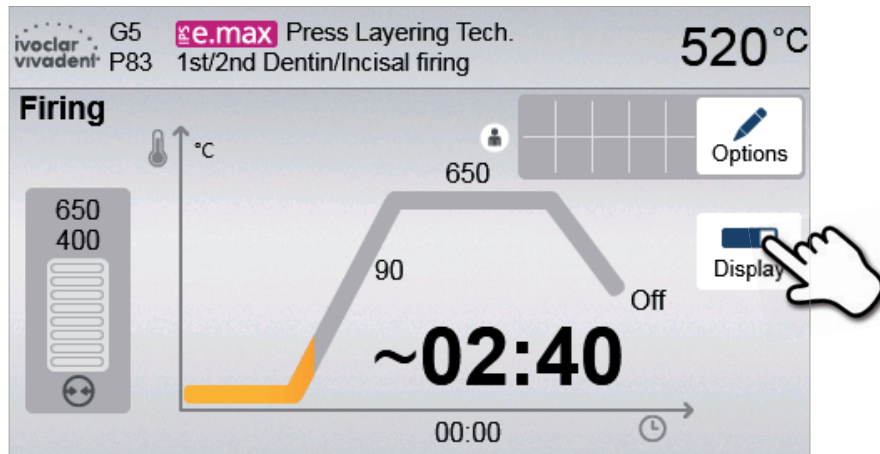

If the **[Display]** button is pressed while the firing curve is displayed, the remaining time will be shown. The remaining time indicator informs the user about the time that is left until the process is completed even from a distance. The remaining time is displayed in the centre of the screen in large characters.

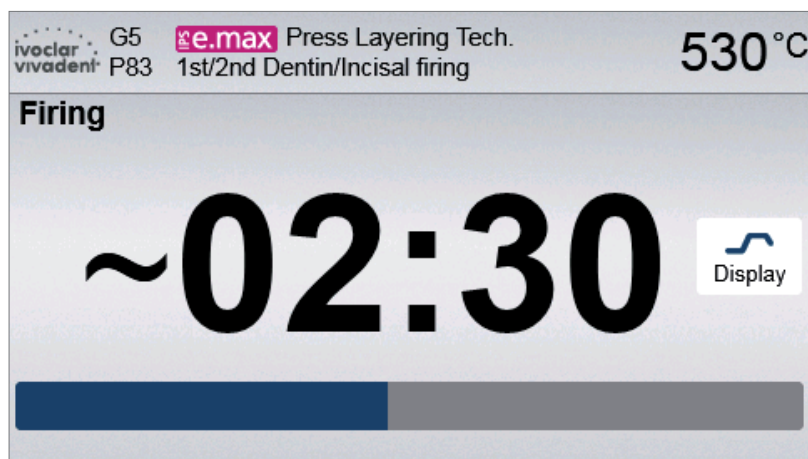

The factory settings of the furnace are such that the firing curve is automatically displayed upon the start of a program.

5. Operation and Configuration

5.2.7 Pausing the active program

- Press STOP once to pause a running program (green LED flashing). Press the STOP key twice to completely stop the program or press START to continue.
- If the program is paused, the display shows a flashing "Pause" and the indicator changes back to the program screen.
- If a program is stopped prematurely, "Vacuum release" is shown in the display during the flooding of the firing chamber.

5.2.8 Changing the parameters while the program is running

Most program parameters, which have not yet been executed, can be changed while the program is paused. Change the parameters as described in Chapter 5.2.3.

5.3 Managing programs

Press the button [Admin] in the program view to open the managing program menu.

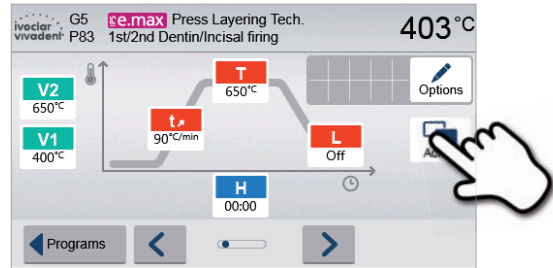

The following functions are available:

- Copy programs
- Reset program to factory settings
- Select product logo
- Rename group name
- Rename program name



5.3.1 Copying programs

With the copy assistant program sectors can be copied. The source and target of the copy process can be selected in the copy assistant. Programs copied to a USB flash drive can only be opened with this furnace. PrograBase X10 offers the possibility to copy the programs to other furnaces.

1. Press the corresponding [Execute] button in the Admin menu.



2. Select the items you want to copy.

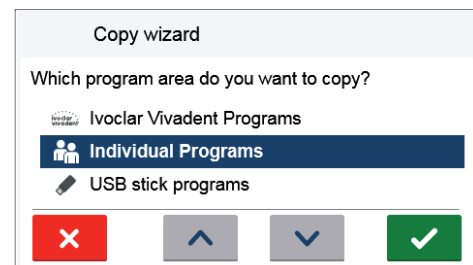

3. Select target.

The selection can be confirmed with the green button. The red button is used to close the copy assistant.

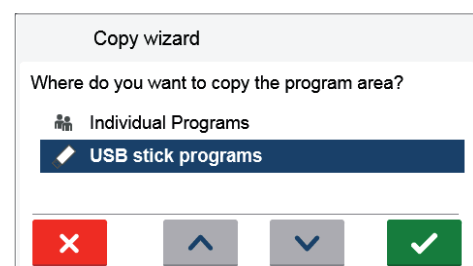

5. Operation and Configuration

- 4. The copy process can be continued with the green button. The red button is used to abort the copy process.

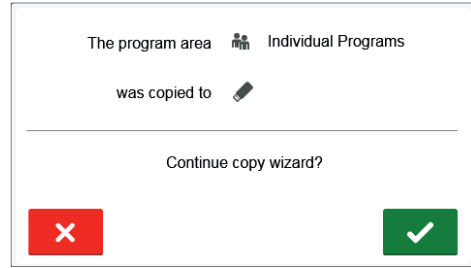

5.3.2 Selecting product logo

The product logo for the current group can be selected.

- 1. Press the corresponding button in the Admin menu.

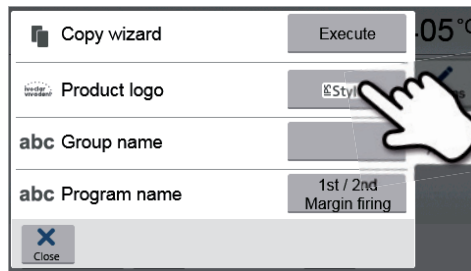

- 2. Select the desired product logo. Confirm the entry with the green button.

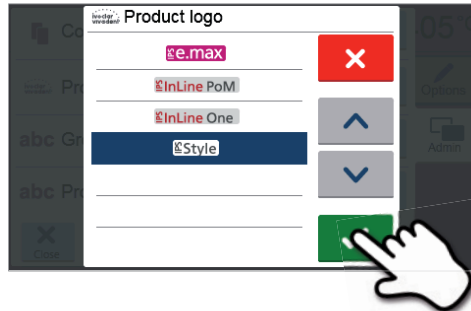

5.3.3 Renaming program, program group

The current program and current program group can be renamed (only possible for individual programs).

- 1. Press the corresponding button in the Admin menu and select whether the program or group name should be changed.

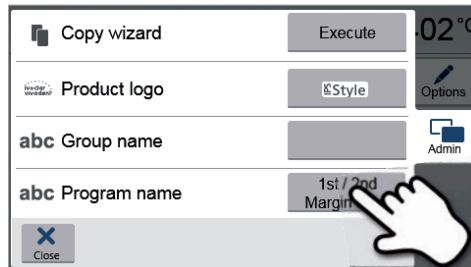

- 2. Enter the desired program or group name. Confirm the entry with the green button.

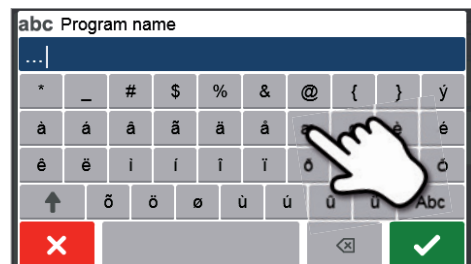

5.4 Advanced functions of the furnace / Software update

5.4.1 Settings

To reach the Settings menu, scroll to page 2 in the home screen and press the **[Settings]** touch button.

Example: *Changing the brightness of the display*

1. Open Settings

Scroll to page 2 in the home screen and press the **[Settings]** button.

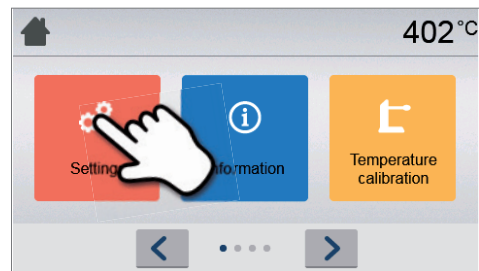

2. Open display brightness

The **[Arrow]** buttons are used to scroll through the Settings menu. Press the button until the setting "Display brightness" appears in the display.

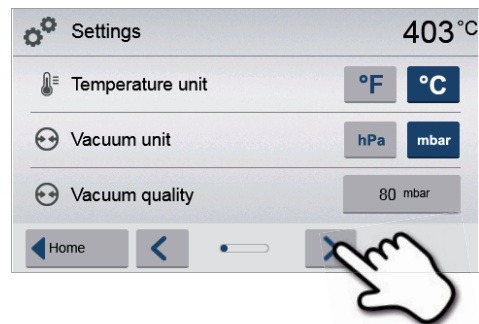

3. Change the brightness of the display

Press the touch button in the line "Display brightness".

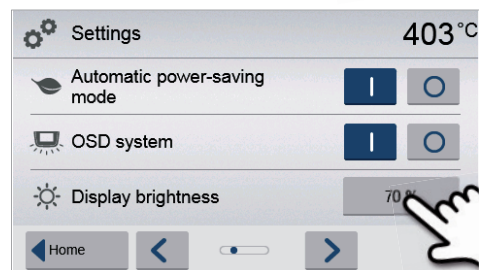

4. Select the desired display brightness

in percent and confirm the entry with the green button or cancel the entry with the red button.



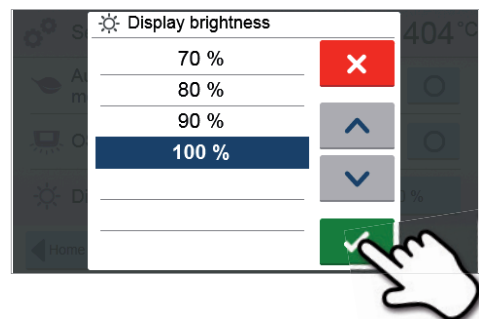











The setting was changed.

















To return to the home screen, press either the touch button **[Home]** in the navigation bar or the HOME key on the membrane-sealed keypad.

5. Operation and Configuration

The following settings can be changed in the Settings menu:

| | |
|---|---|
|  | Temperature unit You can choose between °C and °F. <i>Setting options: °C / °F</i> |
|  | Vacuum unit You can choose between mbar and hPa. <i>Setting options: mbar / hpa</i> |
|  | Vacuum quality Setting the final vacuum value. This value defines the negative pressure in the furnace head at which the furnace has reached a vacuum quality of 100%. <i>Setting options: 0–200 mbar</i> |
|  | Language Select the desired operating language. <i>Setting options: German, English, Italian, French, Spanish, Portuguese, Swedish, Dutch, Turkish, Russian, Polish, Croatian, Traditional Chinese, Mandarin Chinese, Finnish, Norwegian, Slovenian, Czech, Slovakian, Hungarian, Hindi, Japanese, Korean, Arabic, Farsi</i> |
|  | Volume Select the desired volume of the acoustic signals. <i>Setting options: Off/20–100% in 10% steps</i> |
|  | Melody Select the desired melody for the acoustic signal. <i>Setting options: Melody 1 to 20</i> |
|  | Time Set the current time. <i>Setting options: hh:mm:ss</i> |
|  | Date Set the current date. <i>Setting options: according to the set date format</i> |
|  | Date format Set the date format. <i>Setting options: dd:mm:yyyy; mm:dd:yyyy</i> |
|  | Time zone Set the respective time zone. <i>Setting options: from 11 to +12 hours (revolving)</i> |
|  | Power-saving mode If the power-saving mode is activated and the furnace head closed, this function is automatically started after 30 minutes, if the furnace is on stand-by and no key is pressed during that time. The display shows the power-saving icon. Pressing any key ends the automatically activated power-saving function. <i>Setting options: On/Off</i> |
|  | Optical Status Display (OSD) Here, the OSD can be switched on or off. <i>Setting options: On/Off</i> |
|  | Display brightness Set the display brightness. <i>Setting options: 20–100% in 10% steps</i> |
|  | Testing push notifications Here, push notifications for communicating with the Programat app can be tested. The Programat app must be linked to the furnace to test push notifications. If the network has been set up correctly, a push notification will appear on the Programat app. If no notification appears on the app, please check the network settings. |

| | |
|---|--|
|  | User code The user code can be individually changed.  We recommend noting down the individually changed user code and keep it separately from the furnace. A forgotten user code can only be reset with the help of the After Sales Service! <i>Setting options: 1000 to 9999</i> |
|  | Operating mode Set the desired operating mode. See Chapter 5.3.8 Operating mode for details <i>Setting options: Standard / Protected / Production</i> |
|  | Protocolling If this function is activated, the program data are saved in a protocol entry after every firing procedure. The following protocol settings are available: Inactive: Protocolling is not active. Printer: At the end of the program, the parameters used are logged and saved in the furnace. Additionally, the protocols are printed on a connected USB printer. PC: At the end of the program, the parameters used are logged and saved in the furnace. If the furnace is connected to the PrograBase software, the saved table entries are synchronized with the connected laptop/PC. Protocols can be edited, saved and printed by means of the PrograBase software. <i>Setting options: Inactive / Printer / PC</i> |
|  | Laboratory name The laboratory name can be entered here. It is automatically added to the protocols. <i>Setting options: Laboratory name entry</i> |
|  | Furnace number Here, you can enter a furnace number. The number will be prominently shown in the display when the operating mode (Production) is activated. <i>Setting options: 1 to 99</i> |
|  | Calibration interval Set the notification as to when the next calibration should be conducted. <i>Setting options: 1 / 3 / 6 / 12 months</i> |
|  | Resetting heating muffle firing hours to zero If this function is executed, the heating muffle firing hours are set to "zero". This function can only be executed by entering the user code. |
|  | Resetting the vacuum pump hours to zero If this function is executed, the vacuum pump hours are set to "zero". This function can only be executed by entering the user code. |
|  | Resetting to factory settings If this function is executed, all programs and settings are reset to the status before the initial start-up. This function can only be executed by entering the user code. |
|  | Preparing USB stick programs If this function is executed, a USB stick is prepared as program memory. |
|  | Touch mode Setting the sensitivity of the touch screen. Select "Special" in case of malfunctions when operating the touch screen. <i>Setting option: Normal / Special</i> |
|  | Keypad tone Here, the keypad tone can be activated. <i>Setting option: On/Off</i> |
|  | IoT function The IoT function can be activated and deactivated here. Moreover, the connectivity status is indicated. In addition, the time zone can be set in this section. |

5. Operation and Configuration

5.4.2 Information

To reach the screen for the furnace information, scroll to page 2 in the home screen and press the **[Information]** touch button.

Example: Displaying information

1. Open information

Scroll to page 2 in the home screen and press the **[Information]** button.

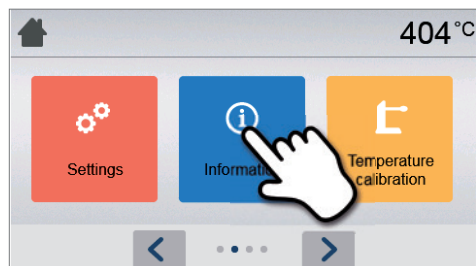

2. Read information



The information is displayed on several pages. The **[Arrow]** buttons are used to scroll to the next information page.

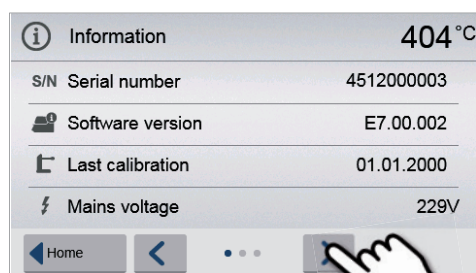

To return to the home screen, press either the touch button **[Home]** in the navigation bar or the HOME key on the membrane-sealed keypad.



The following information can be read off:

| | |
|---|--|
|  | Serial number Serial number of the furnace. |
|  | Software version Currently installed software version of the furnace. Software updates are available from www.ivoclarvivadent.com/downloadcenter . |
|  | Last calibration Date of the last calibration |
|  | Mains voltage Currently measured mains voltage |
|  | Last dehumidification Date of the last dehumidification of the furnace |
| h | Operating hours Number of operating hours |
| h | Firing hours Number of firing hours |
| h | Vacuum hours Number of operating hours of the vacuum pump |
| IP | IP address IP address indication |
| IP | Internet connection Indicates if the furnace is connected to the Internet |
| IP | MAC address Indication of the MAC address |
|  | Video tutorials Display of the QR code to access the video tutorials |

5.4.3 Temperature calibration

The sheathed thermocouple and heating muffle of the furnace may be subject to changes which affect the furnace temperature, depending on the mode of operation and the frequency of use. Check furnace temperature with the "Silver Test" at least every six months and adjust if necessary.

In manual temperature calibration, the melting point of silver (961 °C) is used as a reference. For this purpose, the melting condition of a silver wire must be visually assessed and the calibration value adjusted depending on the result.

If the silver wire has:

- started to melt: Temperature ideal (Fig. 1)
- not started to melt: Temperature too low – increase calibration value
- melted down to a ball: Temperature too high (Fig. 2) – reduce calibration value

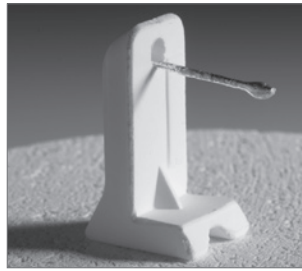

Fig. 1: Temperature ideal

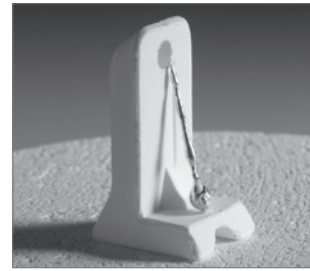

Fig. 2: Temperature too high

Experience has shown that a recalibration of $\pm 5\text{ °C} / 9\text{ °F}$ is appropriate. After adjusting the calibration value, run the calibration program again until the silver wire has correctly started to melt (Fig. 1).

Temperature calibration requires only few steps:

1. Open temperature calibration

Scroll to page 2 in the home screen and press the [Temperature calibration] button.



The furnace must be heated up and have reached its stand-by temperature (403 °C) before the calibration is started.

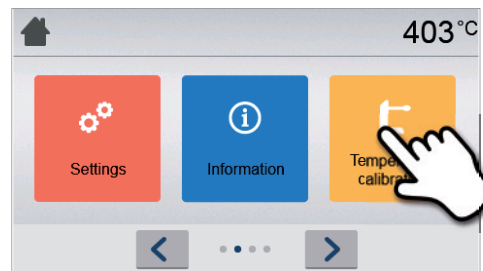

2. Start the calibration

The display shows the latest calibration value and the date of the latest calibration.

Press the START key on the membrane-sealed keypad to start the calibration.

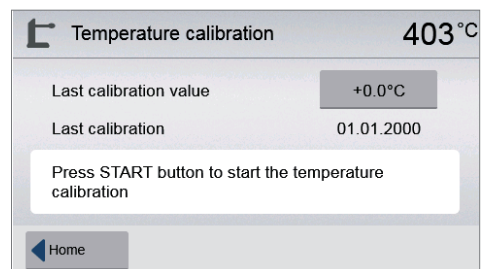

3. Place the calibration sample

Follow the instructions on the display and place the Ivoclar Vivadent sample holder with the silver strip in the centre of the firing plate (without firing tray) and press the START key.

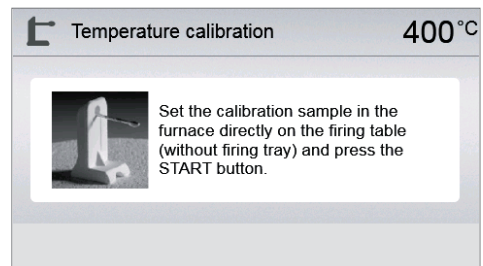

5. Operation and Configuration

4. The status bar shows the duration of the calibration program.

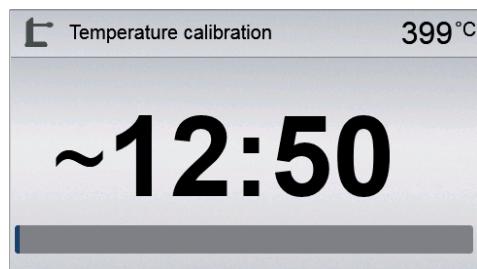

5. Assess the calibration sample and adjust the calibration value

Assess the sample after the calibration program has ended. Observe the assistance on the display.

Press the input field in the display to adjust the calibration value.

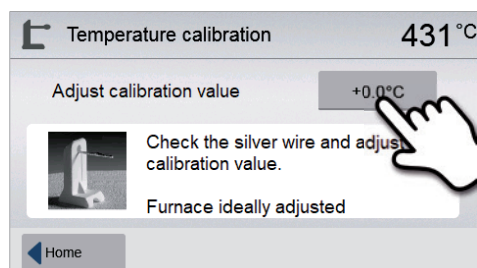

6. Enter the calibration value

Enter the calibration value by means of the +/- buttons and confirm your entry with the green button.

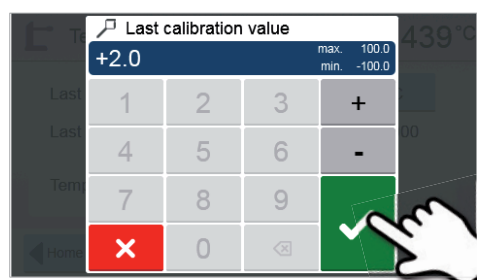

7. Re-calibration

The calibration value has been saved. Run the calibration program again and make sure that the silver wire has correctly started to melt (Fig. 1).

Adjust the calibration value again if necessary.

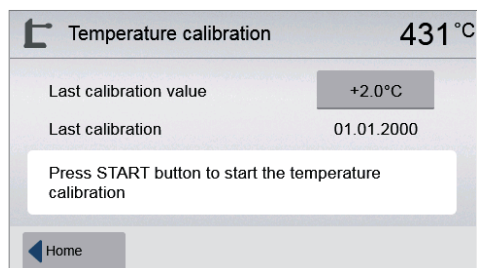

To return to the home screen, press either the touch button **[Home]** in the navigation bar or the HOME key on the membrane-sealed keypad.

5.4.4 Data backup

With the data backup function, individual programs and settings can be backed-up on a USB flash drive. We recommend using this feature, e.g. before a software update or before sending in the furnace for maintenance purposes.

Moreover, furnace data saved on a USB flash drive can be restored on the furnace. However, restoring only works on the same furnace with the identical serial number.

The procedure is identical for both functions and requires only few steps:

1. Open data backup

Scroll to page 3 in the home screen and press the **[Data Backup]** button.

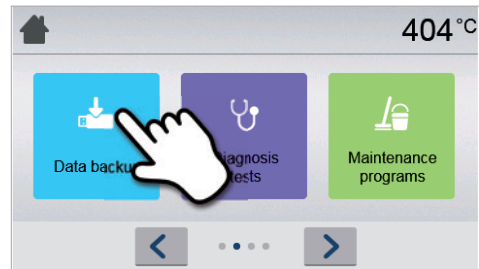

2. Conduct the data backup

Connect a USB stick to the furnace and press the **[Execute]** button.

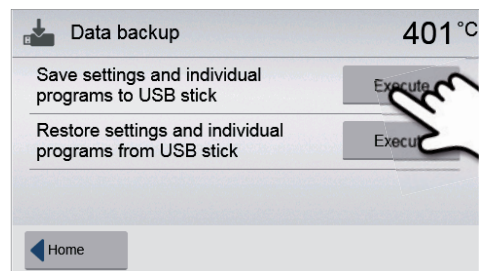

3. Complete the data backup

✓ Data backup successful

✗ Data backup failed

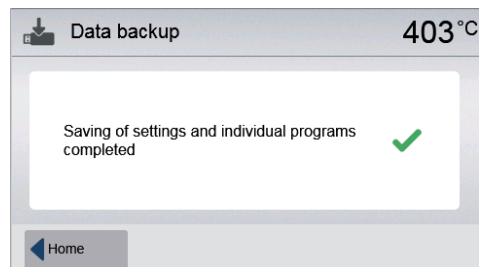

To return to the home screen, press either the touch button **[Home]** in the navigation bar or the HOME key on the membrane-sealed keypad.

5. Operation and Configuration

5.4.5 Software Update

Software updates can be easily installed on the furnace by means of a USB stick. A USB memory stick which contains a current software file (e.g. P310 G2:V1.10.iv) is required for the update. The software version on the USB memory stick must be higher than the one installed on the furnace (see Selection – Information).

The free software updates for Programat furnaces are available from www.ivoclarvivadent.com/downloadcenter.



Back-up your data before performing a software update.

A software update requires only few steps:

1. Open software update

Scroll to the fourth page in the home screen and press the **[Software update]** button.

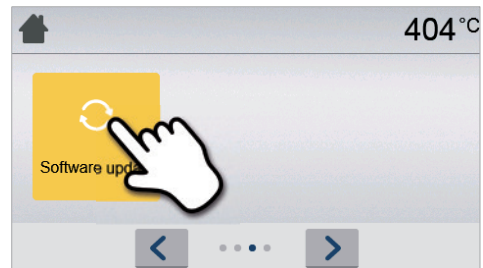

2. Conduct a software update

If the USB stick with the software file is already connected, the furnace automatically searches for a valid software file. If the USB stick has not yet been connected with the furnace, do so now. Press the **[Execute]** button.

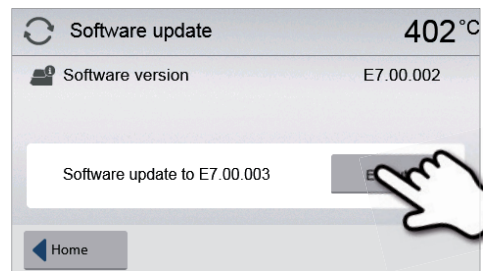

3. The status bar shows the progress of the update.

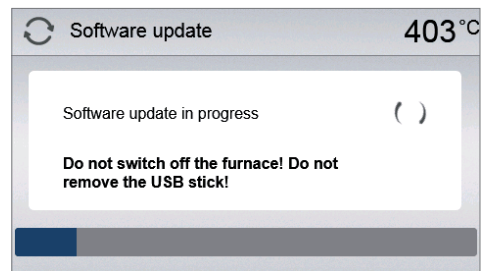

4. Complete the software update

The following messages are displayed:

✓ Software update successful

✗ Software update failed

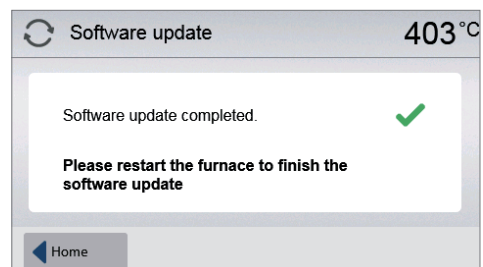

The furnace has to be switched off and on again by means of the mains switch at the rear of the furnace (24) to complete the software update.



Important information

Please note that modified Ivoclar Vivadent programs may be overwritten during a software update. Individual programs are not affected and will not be overwritten.

5.4.6 Diagnosis

Scroll to page 3 in the home screen and press the **[Diagnosis]** button.

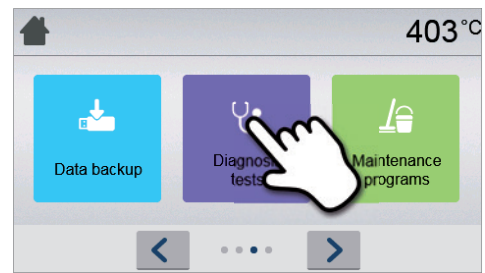

The following functions are available in the Diagnosis menu:

- tests (e.g. vacuum test, heater test, etc.)
- error table (saved error messages)
- remote diagnostic
- service

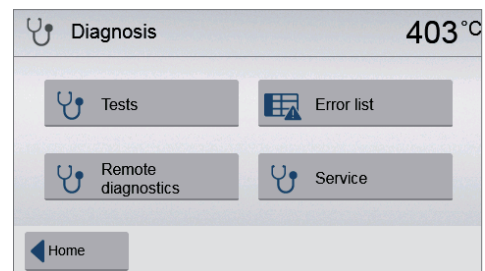

5.4.6.1 Tests (test programs)

- Vacuum pump test program

With the vacuum pump test program, the vacuum performance and tightness of the furnace vacuum system can be automatically tested. For that purpose, the achieved (minimum) pressure in mbar is measured and indicated. If the pressure value is below 80 mbar (hPa), the vacuum performance of the system is adequate.

- Heating muffle test

The quality of the heating muffle may be automatically checked by means of the heater test (duration: approximately 7 minutes). The heater test should only be conducted with the empty firing chamber, since an object in the chamber (e.g. firing tray) may influence the test result. Conduct the heater test immediately after switching on the furnace and before any actual firing procedures are conducted. If the furnace is too hot, an incorrect heating muffle quality will be indicated. If the heating element quality falls below 50%, replacing the heating element is recommended.

- Keypad / touch test

Each time the keypad or the touch buttons are pressed, a short acoustic signal sounds to confirm its function.

- Display test

Two different chequerboard patterns are alternately shown in the entire display. Every individual pixel can be visually checked.

- OSD test

The OSD test checks the LEDs of the Optical Status Display. During the test, the OSD lights up in different colours.

5.4.6.2 Error table

Every error message is saved in an error table after it occurred. The **[Arrow]** button is used to scroll through the list. The last 20 error messages are listed.

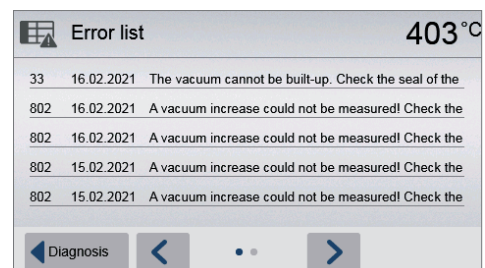

5. Operation and Configuration

5.4.6.3 Remote diagnostic

The remote diagnostic function helps you in case of a possible problem with your Programat furnace and facilitates the communication between users and the Ivoclar Vivadent After Sales Service.

If the diagnostic function is executed, the furnace generates a diagnostic file, which is automatically saved on the USB stick. The file can be sent by e-mail or analyzed by means of PrograBase on a lap-top/PC.

The diagnostic file provides furnace information (e.g. installed software version, set modes, etc.), operating data (e.g. operating hours, firing hours, etc.), calibration data (e.g. calibration values, date of the last calibration, etc.), test results and saved error messages.

Generating a diagnostic file:

1. Open the diagnosis function

Press the **[Remote diagnostic]** button in the Diagnosis menu.

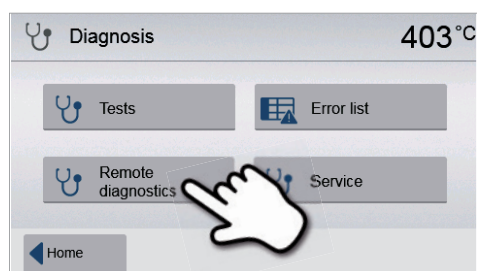

2. Generate a diagnostic file

Connect a USB stick with the furnace. Press the **[Execute]** button.

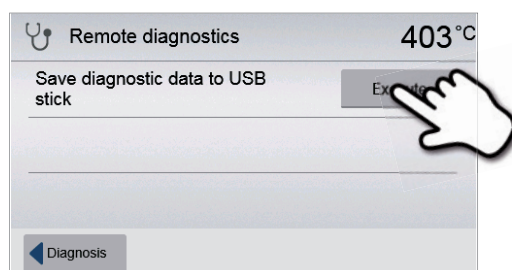

3. Once the diagnostic file has been generated, the following message is displayed:

- ✓ Diagnostic successful
- ✗ Diagnostic failed

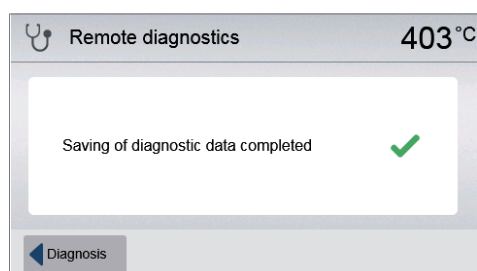

4. Forward or analyze the diagnostic file

Connect a USB stick with a laptop/PC. The file can only be analyzed by means of the PrograBase software or sent to any e-mail address.

If the furnace is connected with a laptop/PC via Ethernet, the file can also be directly opened, forwarded or analyzed by the PrograBase software.

5.4.7 Maintenance Programs

Scroll to page 3 in the home screen and press the **[Maintenance Programs]** button.

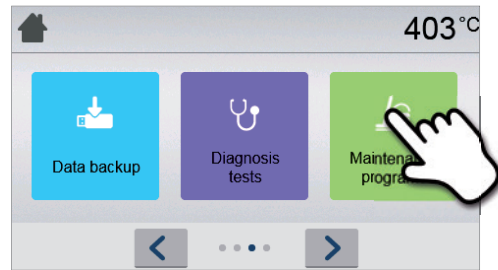

The following programs are available in the Maintenance Programs menu:

- Dehumidification program
- Cleaning program

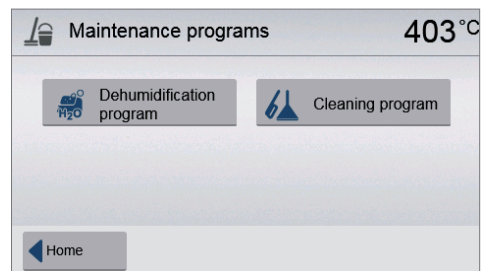

5.4.7.1 Dehumidification program

The condensation of water in the insulation of the firing chamber and the vacuum pump will result in a lower vacuum and thus in impaired firing results. For that reason, the furnace head should be kept closed when the furnace is switched off or the temperature is below 100 °C, in order to prevent the absorption of humidity.

Conducting the dehumidification program:

1. Open the dehumidification program

Scroll to page 3 in the home screen and press the **[Maintenance Programs]** button. Press the **[Dehumidification program]** button in the Maintenance Programs menu.

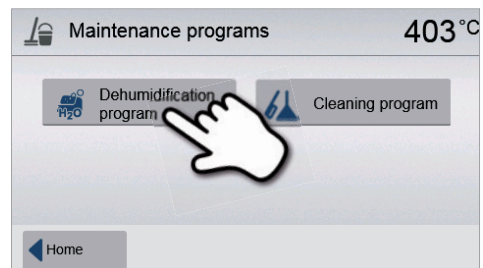

2. Start the dehumidification program

Press the START key to start the dehumidification program.

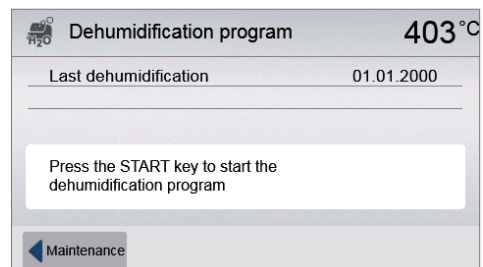

5. Operation and Configuration

3. The status bar shows the progress of the dehumidification program.

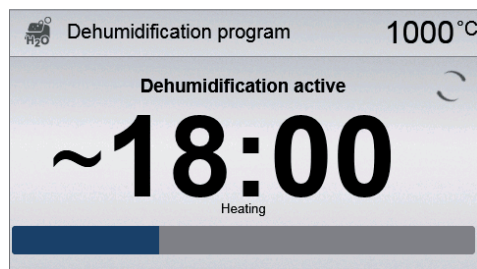

4. End of dehumidification program

The following messages are displayed:

- ✓ Dehumidification program successful
- ✗ Dehumidification program failed

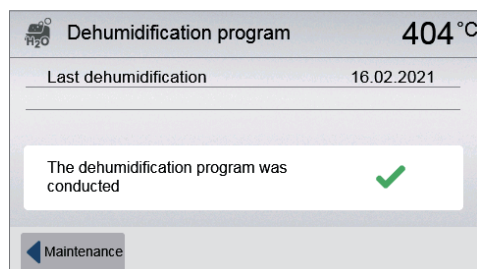

During an active dehumidification program, the furnace head is automatically opened and closed. This supports the evaporation process of the condensed water. Do not interrupt this process.

5.4.7.2 Cleaning program

The cleaning program is used to “clean” the heating muffle (duration: approx. 17 min.). After a cleaning program, it is recommended to calibrate the furnace. In case of problems with discolouration of the ceramic, we recommend cleaning the firing table or replacing the firing tray material.

To start the cleaning program, proceed as described in the section on the dehumidification program.

5.4.8 Operating mode

Various operating modes can be selected in the Settings menu. In this way, the user safety is enhanced and adjusted to the area of application. The following modes are available:

- **Standard:** All functions of the furnace are available in this mode.
- **Protected:** Only programs can be selected and started in this mode. Programs cannot be changed. Settings or special functions cannot be activated or changed. In the protected mode, the production mode can only be activated or deactivated by entering the user code.
- **Production:** In this mode, only one program can be accessed. Only the functions Open/Close furnace head and Start/Stop program are available. Only that program is available, which was loaded in the furnace at the time the production mode was selected. Help notes on the operation are shown in the display. The production mode can only be activated or deactivated by entering the user code.

The selection of the operating mode requires only few steps:

1. Change the operating mode

Open the Settings menu and press the button in the line "Operating mode".

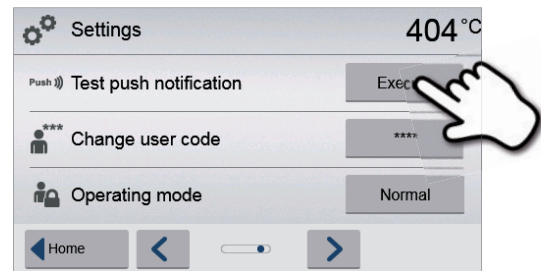

2. Enter the user code

Enter the user code and confirm the entry with the green button.



3. Select the operating mode

Select the desired operating mode and confirm the entry with the green button.

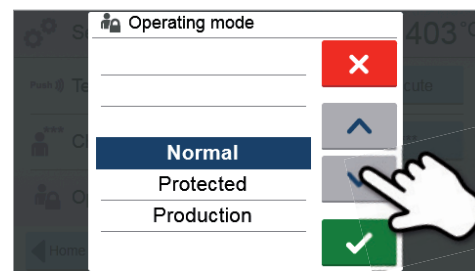

4. Program screen in the operating mode "Production" (example)



The "Protected" or "Production" modes can be quit by prolonged pressing of the HOME key (at least 3 seconds).

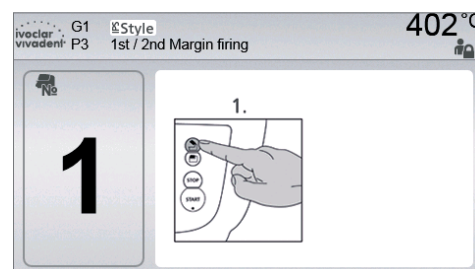

5.5 IoT function

5.5.1 Description of the IoT function

The IoT function enables you to optimize your device software and supports the fast trouble shooting in case of a technical problem.

More information about the IoT function can be found at <http://www.ivoclarvivadent.com/digitalservices>

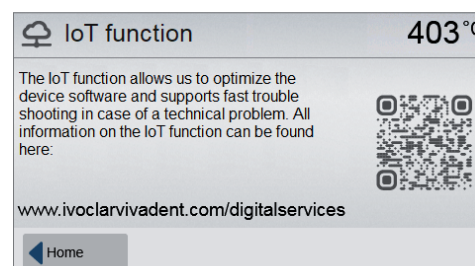
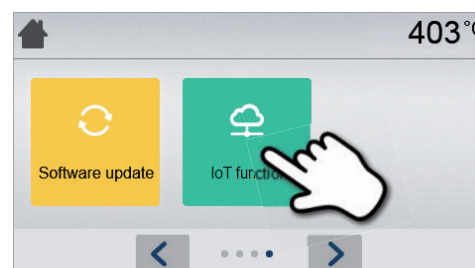

6. Practical Use

The operating procedure for the Programat P310 G2 will be explained with the help of two examples: one Ivoclar Vivadent and one individual program.

6.1 Firing with an Ivoclar Vivadent program

Step 1:

Switch on

Switch on the furnace with the mains switch at the rear of the furnace. The furnace conducts an automatic self-test.

Wait until the furnace has reached the set stand-by temperature.

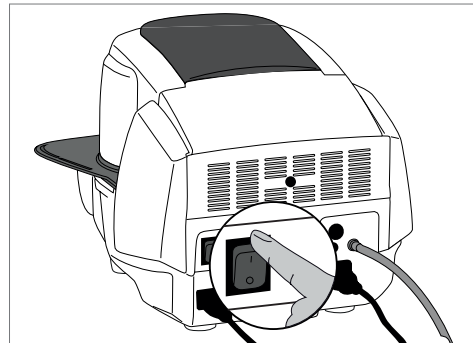

Step 2:

Select the program

After the self-test, the display shows the home screen. Press the [Ivoclar Vivadent Programs] button.



Select the desired program group.

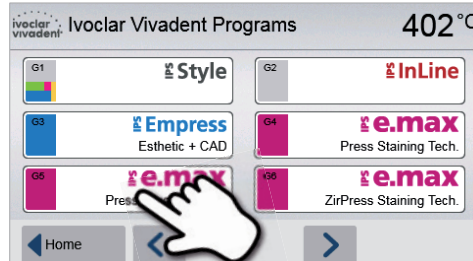

Select the desired program.



Step 3:

Load the furnace

Open the furnace head with the OPEN FURNACE HEAD key and place the object on the firing tray in the furnace.

Step 4:

Start the program

Press the START key to start the program. The LED lights up in green. You can observe the course of the program on the firing curve display.

The furnace head opens automatically at the end of the program. If the Optical Status Display (OSD) lights up green, the furnace is ready for the next program start.

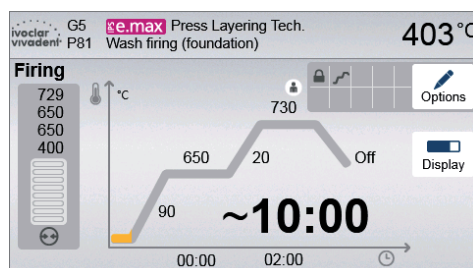

6.2 Firing with an individual program

Step 1:

Switch on

Switch on the furnace with the mains switch at the rear of the furnace. The furnace conducts an automatic self-test.

Wait until the furnace has reached the set stand-by temperature.

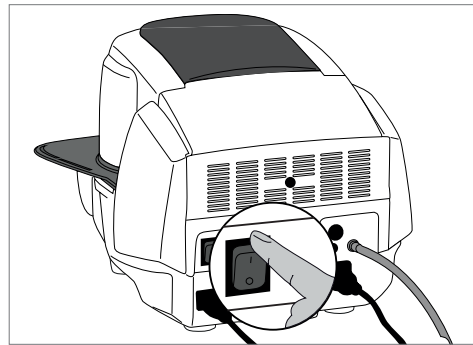

Step 2:

Select the program

After the self-test, the display shows the home screen. Press the [Individual Programs] button.



Select the desired program group.

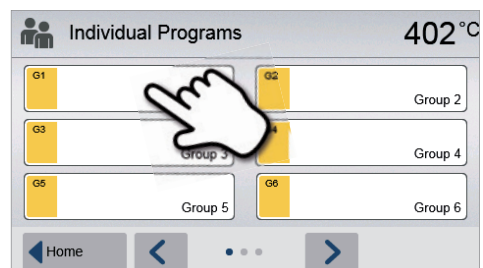

Select the desired program.

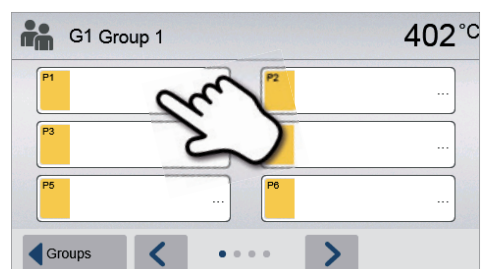

Step 3:

Enter the parameters

Enter the individual parameters and create the desired firing program (see Chapter 5.2.3 for details).



Step 4:

Load the furnace

Open the furnace head with the OPEN FURNACE HEAD key and place the object on the firing tray in the furnace.

6. Practical Use

Step 5:

Start the program

Press the START key to start the program. The LED lights up in green. You can observe the course of the program on the firing curve display.

The furnace head opens automatically at the end of the program. If the Optical Status Display (OSD) lights up green, the furnace is ready for the next program start.

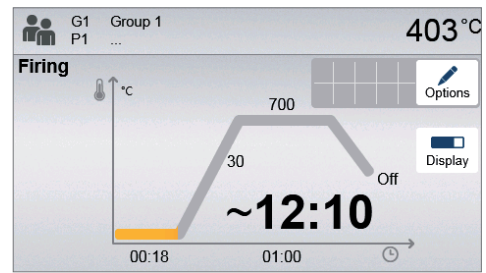

7. Maintenance, Cleaning, Diagnosis

This chapter describes the user maintenance and cleaning procedures for the Programat P310 G2. Only those tasks are listed that may be performed by dental professionals. All other tasks must be performed by qualified service personnel at a certified Ivoclar Vivadent Service Centre.

7.1 Monitoring and maintenance

The time for these maintenance procedures depends on the frequency of use and the working habits of the users. For that reason, the recommended times are only approximations.

| What | Part | When |
|--|---|--------------|
| Check all plug-in connections for correct fit. | Various external connections | weekly |
| Check if the furnace head opens smoothly and without excessive noise. | Opening mechanism | monthly |
| Check if the thermocouple is straight and in the right place. | Thermocouple | weekly |
| Check the insulation for cracks and damages. If the insulation is worn down it has to be replaced by a certified Ivoclar Vivadent Service Centre. Fine hairline cracks on the surface of the insulation are harmless and do not influence the function of the furnace in a negative fashion. | Insulation | monthly |
| Check if the sealing rims of the furnace head and furnace base are clean and undamaged. | Sealing rims of the furnace head and the furnace base | weekly |
| Check the membrane-sealed keypad for visible damage. If the keypad is damaged, it has to be replaced by a certified Ivoclar Vivadent Service Centre. | Membrane-sealed keypad | weekly |
| Check the temperature. Use the temperature checking set to check and adjust the temperature in the furnace. | Firing chamber | twice a year |
| Check the quartz glass cylinder to make sure the quartz glass is not defective. | Firing chamber | daily |
| Check if there is condensate in the vacuum hose or firing chamber. | Vacuum hose, Firing chamber | monthly |



This furnace has been developed for typical use in dental laboratories. If the product is used in a production enterprise, for industrial application and for continuous use, premature ageing of the expendable parts has to be expected. The expendable parts are, for example, the heating muffle, the furnace head sealing rim or the insulation material.

Expandable parts are not covered by the warranty. Please also observe the shorter service and maintenance intervals.



In general, the furnace head should not be replaced since the components (furnace head and furnace base) have been coordinated with each other. However, if the furnace head must be replaced for maintenance reasons, subsequent temperature calibration is required.

7. Maintenance, Cleaning, Diagnosis

7.2 Cleaning

The furnace may only be cleaned when it is cool, since there is a burn hazard. Do not use any cleaning solutions. Disconnect the power plug before cleaning.

The following parts have to be cleaned from time to time:

| Item | Frequency | Cleaning material |
|---|-------------|---|
| Furnace housing and furnace head | if required | soft, dry cloth |
| Membrane-sealed keypad and display | if required | soft, dry cloth or Programat cleaning cloth |
| Cooling tray | daily | cleaning brush* |
| Insulation | daily | cleaning brush* |
| Sealing rim of the furnace head and the sealing surface | daily | cleaning brush and a soft cloth |
| Firing table | if required | cleaning brush or sandblasting device |

*Never clean with compressed air!

7.3 Service note

When the service note appears for the first time, the furnace has already more than 1500 firing hours. If the service note is acknowledged, it will reappear every 1000 firing hours.

Ivoclar Vivadent recommends conducting a heater test after a certain number of firing hours and having the heating muffle examined by the Ivoclar Vivadent After Sales Service if necessary.

7.4 Stand-by

We recommend keeping the furnace head closed, especially if the temperature drops below 150 °C. If the furnace head is open, there is a risk that the insulation absorbs humidity and condensation water develops during firing. This negatively affects the vacuum performance and, consequently, the firing results.

7.5 Power-saving mode

If the furnace is not used for longer periods of time, Ivoclar Vivadent recommends to activate the power-saving mode. With the power-saving mode activated, individual components are switched off and the furnace temperature is reduced to 100 °C.

7.5.1 Automatic power-saving mode

The automatic power-saving mode can be activated in the Settings menu.

If the power-saving mode is activated and the furnace head closed, this function is automatically started after 30 minutes, if the furnace is on stand-by and no key is pressed during that time.

The display shows the power-saving icon. Pressing any key ends the automatically activated power-saving function.

7.5.2 POWER SAVING key

The power-saving mode can be manually activated by pressing the POWER SAVING key. This is only possible with the furnace head closed and the furnace on stand-by. The display shows the power-saving icon. Pressing any key ends the power-saving function.

8. What If ...

This chapter will help you to recognize malfunctions and take appropriate measures or, if possible and acceptable, to perform some simple repairs.

8.1 Error messages

The furnace continuously checks all functions during operation. If an error is detected, the respective error message is displayed.

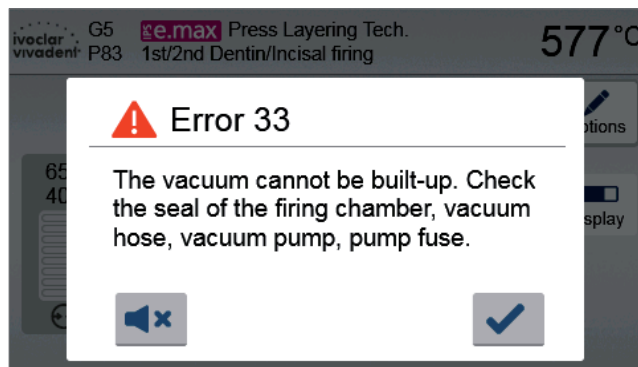

The acoustic signal and the error message can be acknowledged with the corresponding buttons.

The following error messages may be displayed. If there are any questions, please contact the Ivoclar Vivadent After Sales Service.

| Error / Hint No. | Work can continue after the error | Error | Text Error Message |
|------------------|-----------------------------------|---|---|
| 2 | | $T < B$ | Enter an acceptable value for T. |
| 8 | | $L > T$ | Enter an acceptable value for long-term cooling L. |
| 9 | | $V2x \leq V1x$ | Enter an acceptable value for the vacuum-on temperature V1x or the vacuum-off temperature V2x. |
| 10 | | $V2x > T_x + 1^\circ\text{C}$ | Change either the vacuum values or the holding temperature T. |
| 11 | | Incorrect values for V1x, V2x | Enter plausible values for V1x, V2x. |
| 13 *, ** | | Current temperature after start $> T_x + 80^\circ\text{C}$ | Caution: Excess temperature! Program aborted; furnace head opens to cool down the furnace. |
| 14 * | | Temperature in the firing chamber $> 410^\circ\text{C}$ at the start of the calibration program, i.e. too high. | Temperature too high for calibration. Furnace is cooling down! Try restarting the program later. |
| 16 | | $T2 < T1$ | Enter a lower value for T1 or a higher value for T2. |
| 17 | | Power failure > 10 s during a firing program in progress | A program in progress was interrupted for more than 10 s. The program cannot be continued. |
| 18 | | $T1 > V12$ | Enter a lower value for T1 or a higher value for V12. |
| 19 | yes | $V2 < B$ | Prevacuum activated! V2 must be higher than B. |
| 20 ** | no | Error in the heating system | Check the heater fuse. If the fuse is O.K., contact your local Ivoclar Vivadent Service Centre. |
| 23 | | Heating muffle very old | The heating muffle is very old. It is recommended replacing it by a new one. After this error message has been confirmed, a program may still be started. |
| 24 | | Heating muffle defective | The heating muffle is in such poor condition that it has to be replaced immediately. |
| 26 | | Temperature $> B + 160^\circ\text{C}$ at start of a firing program | Firing chamber is too hot for the start of a firing program. |
| 27 **, *** | no | Furnace head cannot be initialized | The furnace head cannot be brought to the end position. It might be blocked by external mechanical influences! If this is not the case, contact your local Ivoclar Vivadent Service Centre. |
| 28 ** | | The furnace head does not reach the target position | Furnace head does not open/close correctly. The furnace head is obstructed or has been moved by hand. Operate the furnace head only with the keys intended for that purpose. |

8. What If ...

| | | | |
|----------|-----|---|---|
| 32 ** | no | The vacuum is not released | The vacuum cannot be released. The vacuum valve might be stuck or dirty. Contact a Service Technician. |
| 33 | | Necessary vacuum (xxxmbar) is not reached within 1 min. | The vacuum cannot be built-up. Check the seal of the firing chamber, vacuum hose, vacuum pump, pump fuse. |
| 110 | | HV > H (H2) | Enter a lower value for HV or a higher value for H (H2). |
| 150 | | Memory Error | Internal memory error. Please restart the device |
| 531 | yes | Error while trying to store firing data | An error occurred while logging firing program data. The storage medium may be full. |
| 702 | | Brief power failure during a program in progress | A program in progress was interrupted by a short power outage. The program is being continued. |
| 800 | | Final vacuum value not reached | The set vacuum end value could not be achieved. Check the vacuum pump. |
| 801 | | Vacuum drop | An unacceptable vacuum drop has occurred. |
| 802 | | The vacuum does not increase (self-test) | A vacuum increase could not be measured! Check the following points: Is the firing chamber tight (no contamination on the sealing surfaces)? Is the vacuum hose connected? Is the vacuum pump connected? Is the fuse F1 in order? |
| 803 | | The vacuum system is not tight | "The tightness of the vacuum system is not given. Check the sealing surfaces for possible contamination. |
| 1501 | yes | Hint -> working hours | The heating muffle has ****working hours. Please perform a heating test (diagnosis) and follow the instructions on the display and in the Operating Instructions. |
| 1510 | | Temperature > VT at the start of a firing program | The temperature of the firing chamber is higher than the predrying temperature. To continue the programm nevertheless, press the Start button. |
| 1522 | | Software update: Error during update. | An error has occurred during the software update. Do NOT switch off the furnace and try again. If the error reoccurs, try conducting the update via the USB interface. |
| 1800 | yes | USB Stick | No USB memory stick available. |
| 1815 | yes | USB Stick | There is no USB stick available or the stick is not prepared as an external program memory. The USB stick can be prepared in the settings menu. |
| 1820 | yes | USB Stick | The USB memory stick is already prepared for programs. |
| 1825 | yes | USB Stick | Please unplug all USB devices and then just plug in the USB memory stick to be prepared. |
| 1830 | yes | USB Stick | Not enough free memory. |
| 1835 | yes | Media playback | Playback of the file is not possible. |
| 1900 | yes | Data backup – recover | The new software contains setting options which were not yet available at the time of the data backup. Only the existing settings of the data backup were restored. |
| 1901 | yes | Data backup – recover | The new software contains program parameters which were not yet available at the time of the data backup. Only the existing program parameters of the data backup were restored. |
| 1902 | yes | Data backup – recover | The new software includes program groups which were not yet available at the time of the data backup. Only the existing program groups of the data backup were restored. |
| 1911 | yes | Data backup – recover | The new software includes program parameters which were not yet available at the time of the data backup. Please check the individual program groups. The individual programs are no longer valid. |
| 1912 | yes | Data backup – recover | The new software includes program groups which were not yet available at the time of the data backup. Please check the individual program groups. The individual program groups are no longer valid. |
| 1920 | yes | Data backup – recover | The data backup could not be performed. Please install a newer software version. |

* Furnace head opens if this error occurs!

** A program in progress is aborted

*** Error cannot be acknowledged; programs cannot be started.

8.2 Additional error messages

Please contact the Ivoclar Vivadent After Sales Service, if one of the following error numbers is being displayed.

25, 29, 43 44, 45, 46, 47, 48, 56,

103, 107, 108, 109, 143, 144, 145, 146, 147

148, 700, 701, 703, 704, 707, 1010, 1011, 1012

1013, 1014, 1015, 1016, 1017, 1018, 1019, 1024, 1025

1026, 1028, 1143, 1144, 1145, 1146, 1147, 1148, 1207

1401, 1402, 1500, 1750, 1751, 1752, 1753

8. What If ...

8.3 Technical malfunctions

These malfunctions may occur without an error message being displayed:

| Error | Double-Check | Action |
|--|--|--|
| Vacuum is not or only slowly released. | Is the vacuum released within approx. 30 seconds? | Wait until the vacuum has been released and remove the object. Switch the furnace on and off again. * |
| Indication on display is incomplete. | Activate the display test program and * | * |
| Display is not illuminated. | Is the furnace properly connected according to the Operating Instructions and switched on? | Correctly connect the furnace and switch it on. |
| Signal transmitter does not sound. | Is the signal transmitter switched off (Volume = 0)? | Adjust volume. |
| Furnace head does not open. | Was the furnace head opened manually? | Open the furnace head only by using the corresponding keys. Switch the furnace off and on again. |
| | Has the vacuum already been released? | Is the program still running? Wait until the program is complete. Switch the furnace on and off again. * |
| Vacuum pump does not start working. | Is the vacuum pump fuse defective? | Check fuse and replace if necessary. |
| | Was the maximum power consumption exceeded? | Use only the vacuum pump recommended by Ivoclar Vivadent. |
| | Is the vacuum pump correctly connected? | Correctly connect the vacuum pump to the furnace base. |
| Final vacuum is not reached. | Is the vacuum hose OK? | Check vacuum hose and hose connection (from the furnace to the pump and from the furnace head to the furnace base). |
| | Is the pump output OK? | Start the vacuum test program. |
| | Humidity/condensation in the vacuum hose? | Start dehumidification program. |
| Incorrect or illogical temperature indication | Is the thermocouple bent or fractured? | Contact your local Ivoclar Vivadent Service Centre. |
| | Is the thermocouple correctly connected? | Correctly connect thermocouple. |
| | Is the thermocouple plug defective? | * |
| Cracks in the insulation | Are the cracks small and insignificant (hairline cracks)? | Small cracks in the insulation do not negatively influence the furnace. |
| | Are the cracks large or have parts of the insulation broken off? | * |
| Cracks in the quartz glass / heating element | Are there cracks in the quartz glass or is the quartz glass sheathing the heating wire broken? | Switch off the furnace.* |
| The firing result does not meet the expectations. | Are the firing parameters correct? | Set the firing parameters according to the instructions of the material manufacturer. |
| | Has the correct firing tray been used? | Use the original Programat firing tray or the special firing tray recommended for the respective material. |
| | Has the furnace been calibrated? | Perform a temperature calibration. |
| | Is the thermocouple damaged or bent? | * |
| The furnace does not send any information to the Programat App (e.g. at the end of a program). | Is the furnace connected to the Internet? | Connect the furnace to the Internet through an Ethernet or WLAN connection. |
| The IoT function of the furnace does not work. | Has the IoT function of the furnace been activated? | Activate the IoT function in the settings. More information can be found at www.ivoclarvivadent.com/digitalservices |

*If there are any questions, please contact the Ivoclar Vivadent After Sales Service.

8.4 Repair



Repairs may only be carried out by a certified Ivoclar Vivadent Service Centre. Please refer to the addresses on the last page of these Operating Instructions.

If repairs during the warranty period are not carried out by a certified Ivoclar Vivadent Service Centre, the warranty will expire immediately. Please also refer to the corresponding warranty regulations.

8.5 Resetting to factory settings

The furnace can be reset to the original settings by resetting to factory settings. In this process, all programs, melodies and volume adjustments are irrevocably reset to the factory settings.

For this purpose, proceed as follows:

1. Open Settings

Scroll to page 2 in the home screen and press the **[Settings]** button.



2. Open "Reset to factory settings"

The **[Arrow]** button is used to scroll through the Settings menus. Press the button until the setting "Reset to factory settings" appears in the display.

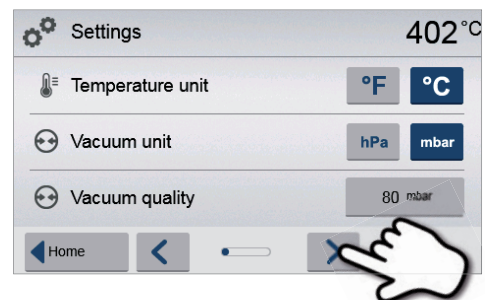

3. Reset to factory settings

Press the **[Execute]** button in "Reset to factory settings".

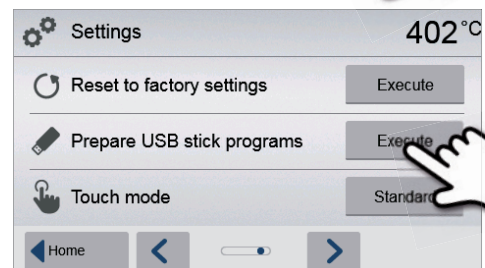

4. Enter the user code

Enter the user code (1234) and confirm the entry with the green button or cancel the entry with the red button.

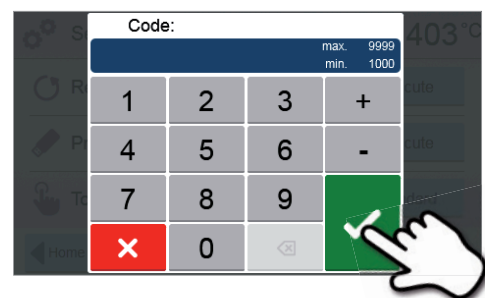

8. What If ...

5. Complete resetting to factory settings

The following messages are displayed:

- ✓ Reset to factory settings successful
- ✗ Reset to factory settings failed

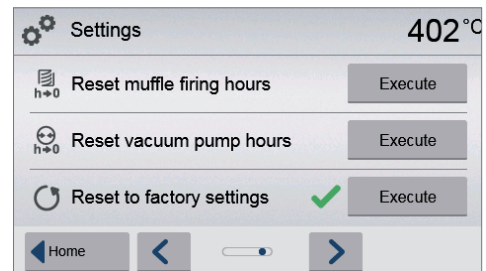

To return to the home screen, press the HOME key on the membrane-sealed keypad.

9. Product Specifications

9.1 Delivery form

- Programat P310 G2
- Power cord
- Vacuum hose
- Programat Firing Tray Set 2
- Temperature Checking Set 2
- LAN download cable
- Operating Instructions
- Various accessories

Recommended accessories

- Temperature Checking Set 2
- Vacuum Pump VP5, VP3 easy

9.2 Technical data

| | |
|--|--|
| Power supply | 110 – 120 V / 50 – 60 Hz 200 – 240 V / 50 – 60 Hz |
| Overvoltage category | II |
| Contamination level | 2 |
| Acceptable voltage fluctuations | ± 10 % |
| Max. power consumption | 12 A at 110 – 120 V 8.5 A at 200 – 240 V |
| Acceptable data for pumps of other manufacturers: Max. output: Final vacuum: | 250 W / max. leakage current 0.75 mA < 50 mbar Only tested pumps should be used |
| Electrical fuses | 110 – 120 V: 125 V / T15A (heating circuit) 125 V / T5A (vacuum pump) 200 – 240 V: 250 V / T8A (heating circuit) 250 V / T3.15A (vacuum pump) |
| Dimensions of electrical fuses | 110 – 120 V: Diameter 6.3 x 32 mm 200 – 240 V: Diameter 5 x 20 mm |
| Dimensions of the closed furnace | Depth: 465 mm Width: 320 mm / 390 mm (with cooling tray) Height: 320 mm |
| Usable size of the firing chamber | Diameter: 90 mm Height: 80 mm |
| Max. firing temperature | 1200 °C |
| Weight | 15.6 kg |

Safety notes

The furnace complies with the following standards:

IEC 61010-1:2010

IEC 61010-1:2010/AMD1:2016

EN 61010-1:2010/A1:2019

UL 61010-1:2012/R:2019-07

CAN/CSA-C22.2 No. 61010-1:2012/A1:2018-11

EN 61010-2-010:2020

IEC 61010-2-010:2019

UL 61010-2-010:2019

CAN/CSA-C22.2 No. 61010-2-010:2019

Radio protection, electromagnetic compatibility: EMC tested

9. Product Specifications

9.3 Acceptable operating conditions

- Acceptable ambient temperature range: +5 °C to +40 °C
- Acceptable humidity range: Relative humidity 80% for temperatures up to 31 °C gradually decreasing to 50% relative humidity at 40 °C, condensation excluded.
- Acceptable ambient pressure: The furnace is tested for use at altitudes of up to 2000 m above sea level.

9.4 Acceptable transportation and storage conditions

- Acceptable temperature range: –20 °C to +65 °C
- Acceptable humidity range: Max. 80% relative humidity
- Acceptable ambient pressure: 500 mbar to 1060 mbar

Use only the original packaging together with the corresponding foam material for shipping purposes.

10. Appendix

10.1 Program table

A program table (°C / °F) is enclosed to these Operating Instructions. If not, please contact your local Ivoclar Vivadent Service Centre.



Important information

The current program table is also available at:
www.ivoclarvivadent.com/downloadcenter

The program tables can be downloaded from the internet as PDF files. Please make sure that your program table complies with the software version you use, as the table is coordinated with the respective software version.

Ivoclar Vivadent – worldwide

Ivoclar Vivadent AG

Bendererstrasse 2
9494 Schaan
Liechtenstein
Tel. +423 235 35 35
Fax +423 235 33 60
www.ivoclarvivadent.com

Ivoclar Vivadent Pty. Ltd.

1 – 5 Overseas Drive
P.O. Box 367
Noble Park, Vic. 3174
Australia
Tel. +61 3 9795 9599
Fax +61 3 9795 9645
www.ivoclarvivadent.com.au

Ivoclar Vivadent GmbH

Tech Gate Vienna
Donau-City-Strasse 1
1220 Wien
Austria
Tel. +43 1 263 191 10
Fax +43 1 263 191 111
www.ivoclarvivadent.at

Ivoclar Vivadent Ltda.

Alameda Caiapós, 723
Centro Empresarial Tamboré
CEP 06460-110 Barueri – SP
Brazil
Tel. +55 11 2424 7400
www.ivoclarvivadent.com.br

Ivoclar Vivadent Inc.

1-6600 Dixie Road
Mississauga, Ontario
L5T 2Y2
Canada
Tel. +1 905 670 8499
Fax +1 905 670 3102
www.ivoclarvivadent.us

Ivoclar Vivadent Shanghai Trading Co., Ltd.

2/F Building 1, 881 Wuding Road,
Jing An District
200040 Shanghai
China
Tel. +86 21 6032 1657
Fax +86 21 6176 0968
www.ivoclarvivadent.com

Ivoclar Vivadent Marketing Ltd.

Calle 134 No. 7-B-83, Of. 520
Bogotá
Colombia
Tel. +57 1 627 3399
Fax +57 1 633 1663
www.ivoclarvivadent.co

Ivoclar Vivadent SAS

B.P. 118
74410 Saint-Jorioz
France
Tel. +33 4 50 88 64 00
Fax +33 4 50 68 91 52
www.ivoclarvivadent.fr

Ivoclar Vivadent GmbH

Dr. Adolf-Schneider-Str. 2
73479 Ellwangen, Jagst
Germany
Tel. +49 7961 889 0
Fax +49 7961 6326
www.ivoclarvivadent.de

Ivoclar Vivadent Marketing (India) Pvt. Ltd.

503/504 Raheja Plaza
15 B Shah Industrial Estate
Veera Desai Road, Andheri (West)
Mumbai, 400 053
India
Tel. +91 22 2673 0302
Fax +91 22 2673 0301
www.ivoclarvivadent.in

Ivoclar Vivadent Marketing Ltd.

The Icon
Horizon Broadway BSD
Block M5 No. 1
Kecamatan Cisauk Kelurahan Sampora
15345 Tangerang Selatan – Banten
Indonesia
Tel. +62 21 3003 2932
Fax +62 21 3003 2934
www.ivoclarvivadent.com

Ivoclar Vivadent s.r.l.

Via del Lavoro 47
40033 Casalecchio di Reno (BO)
Italy
Tel. +39 051 6113555
Fax +39 051 6113565
www.ivoclarvivadent.it

Ivoclar Vivadent K.K.

1-28-24-4F Hongo
Bunkyo-ku
Tokyo 113-0033
Japan
Tel. +81 3 6801 1301
Fax +81 3 5844 3657
www.ivoclarvivadent.jp

Ivoclar Vivadent Ltd.

4F TAMIYA Bldg.
215 Baumoe-ro, Seocho-gu
Seoul, 06740
Republic of Korea
Tel. +82 2 536 0714
Fax +82 2 6499 0744
www.ivoclarvivadent.co.kr

Ivoclar Vivadent S.A. de C.V.

Calzada de Tlalpan 564,
Col Moderna, Del Benito Juárez
03810 México, D.F.
México
Tel. +52 (55) 50 62 10 00
Fax +52 (55) 50 62 10 29
www.ivoclarvivadent.com.mx

Ivoclar Vivadent BV

De Fruittuin 32
2132 NZ Hoofddorp
Netherlands
Tel. +31 23 529 3791
Fax +31 23 555 4504
www.ivoclarvivadent.com

Ivoclar Vivadent Ltd.

12 Omega St, Rosedale
PO Box 303011 North Harbour
Auckland 075, New Zealand
Tel. +64 9 914 9999
Fax +64 9 914 9990
www.ivoclarvivadent.co.nz

Ivoclar Vivadent Polska Sp. z o.o.

Al. Jana Pawła II 78
00-175 Warszawa, Poland
Tel. +48 22 635 5496
Fax +48 22 635 5469
www.ivoclarvivadent.pl

Ivoclar Vivadent LLC

Prospekt Andropova 18 korp. 6/
office 10-06, 115432 Moscow
Russia
Tel. +7 499 418 0300
Fax +7 499 418 0310
www.ivoclarvivadent.ru

Ivoclar Vivadent Marketing Ltd.

Qlaya Main St.
Siricon Building No.14, 2nd Floor
Office No. 204, P.O. Box 300146
Riyadh 11372, Saudi Arabia
Tel. +966 11 293 8345
Fax +966 11 293 8344
www.ivoclarvivadent.com

Ivoclar Vivadent S.L.U.

Carretera de Fuencarral n°24
Portal 1 – Planta Baja
28108-Alcobendas (Madrid)
Spain
Tel. +34 91 375 78 20
Fax +34 91 375 78 38
www.ivoclarvivadent.es

Ivoclar Vivadent AB

Gustav III:s Boulevard 50
169 74 Solna
Sweden
Tel. +46 8 514 939 30
Fax +46 8 514 939 40
www.ivoclarvivadent.se

Ivoclar Vivadent Liaison Office

: Tesvikiye Mahallesi
Sakayik Sokak
Nisantas' Plaza No:38/2
Kat:5 Daire:24
34021 Sisli – Istanbul
Turkey
Tel. +90 212 343 0802
Fax +90 212 343 0842
www.ivoclarvivadent.com

Ivoclar Vivadent Limited

Compass Building
Feldspar Close
Warrens Business Park
Enderby
Leicester LE19 4SD
United Kingdom
Tel. +44 116 284 7880
Fax +44 116 284 7881
www.ivoclarvivadent.co.uk

Ivoclar Vivadent, Inc.

175 Pineview Drive
Amherst, N.Y. 14228
USA
Tel. +1 800 533 6825
Fax +1 716 691 2285
www.ivoclarvivadent.us

Version: 1

Date information prepared: 2021-04

Valid from software V7.0

The apparatus has been developed solely for use in dentistry. Start-up and operation should be carried out strictly according to the Operating Instructions. Liability cannot be accepted for damages resulting from misuse or failure to observe the Instructions. The user is solely responsible for testing the apparatus for its suitability for any purpose not explicitly stated in the Instructions. Descriptions and data constitute no warranty of attributes and are not binding.